

Thanks for downloading this packet!

Terms & Conditions:

1. This printable packet is for personal or classroom use. By using it, you agree to not copy, reproduce, or change any content from the download, except for your own personal, non-commercial use.
2. If you are a teacher, you may distribute the packet to the students in your classroom.
3. If you found this pdf on a site other than teachingmama.org, it is being used in violation of my copyright. Please email me at angela@teachingmama.org if you see this.

Clip Art & Font Credit: Whimsy Clips, The Creative Mill, & Creative Clips.



Thank you for agreeing to my terms and conditions!

Angela - Teaching Mama

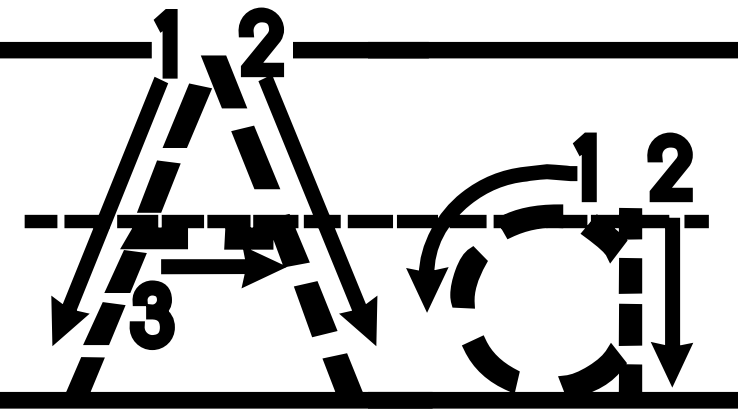

A is for
Arctic
fox

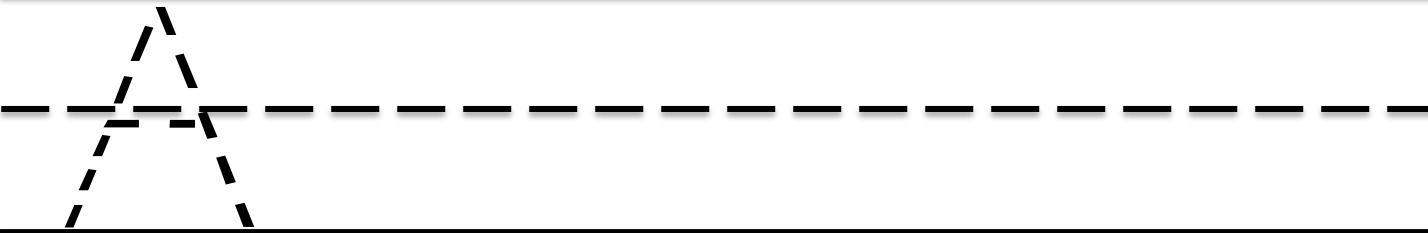
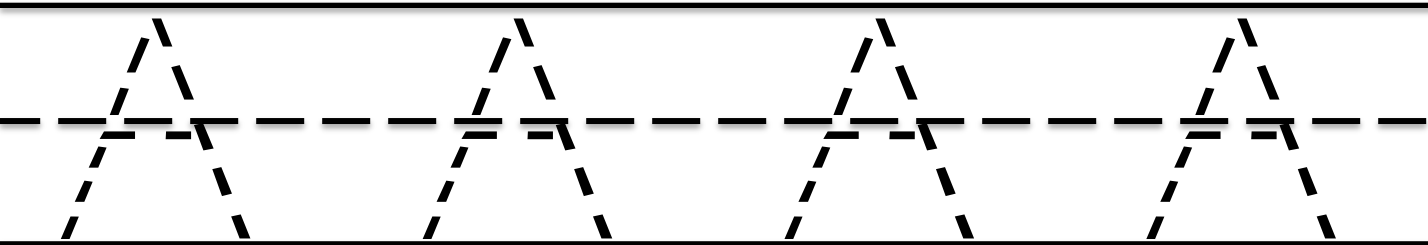

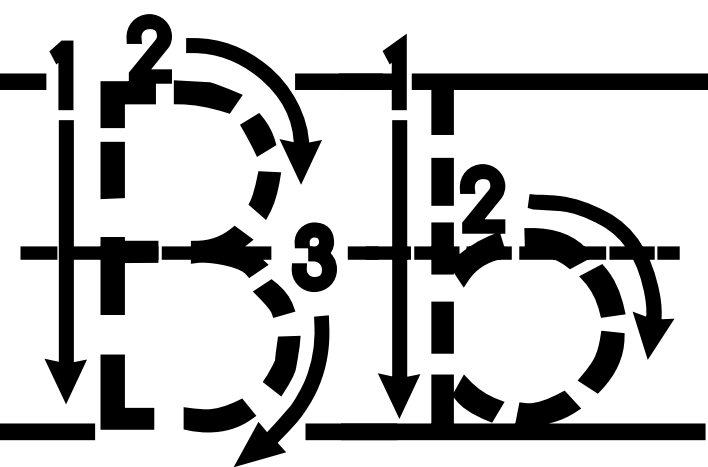

B is for
bear

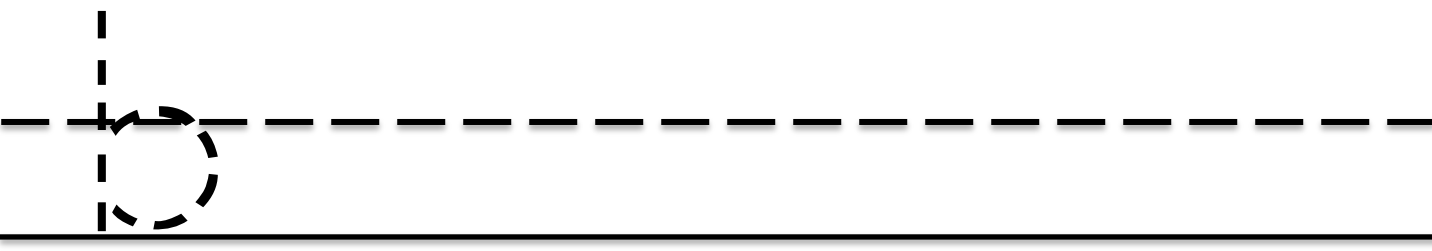
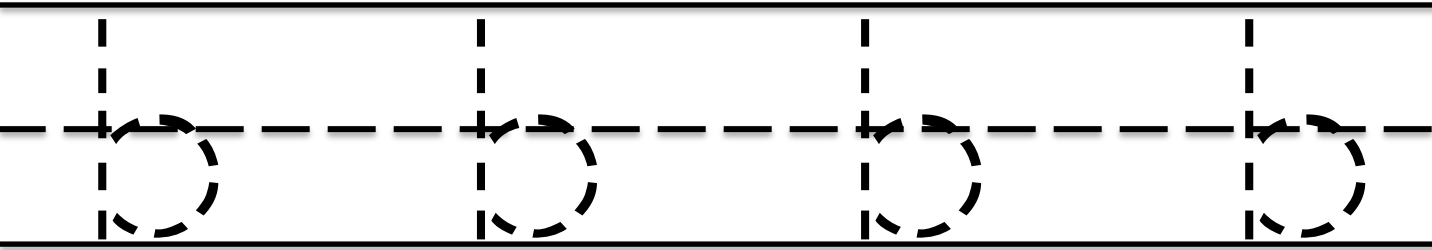
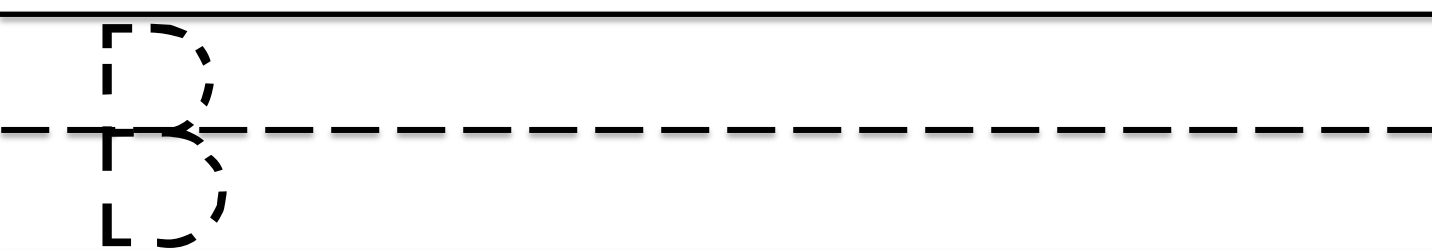
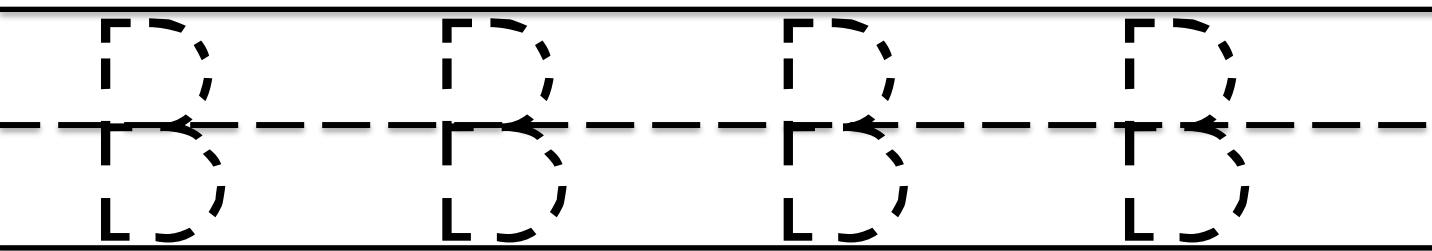

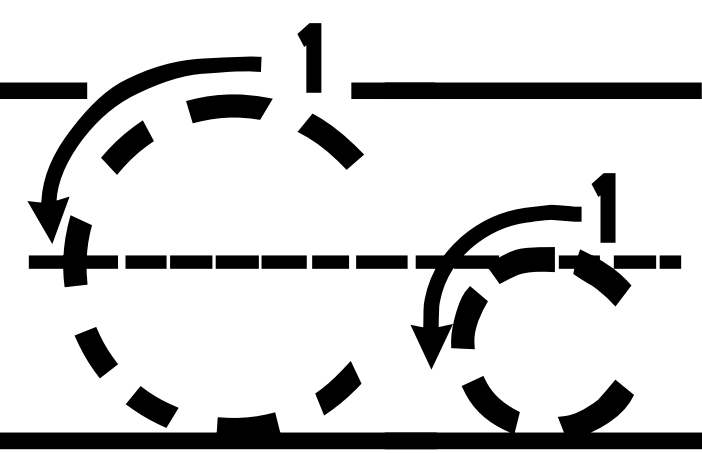

C is for
clouds

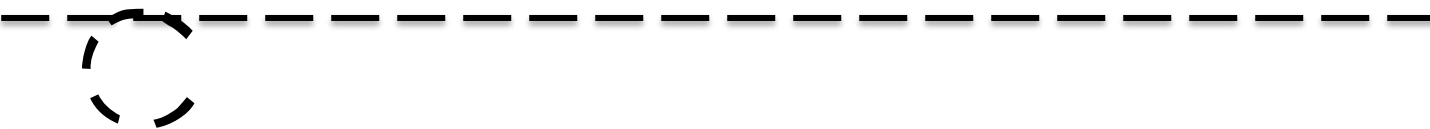
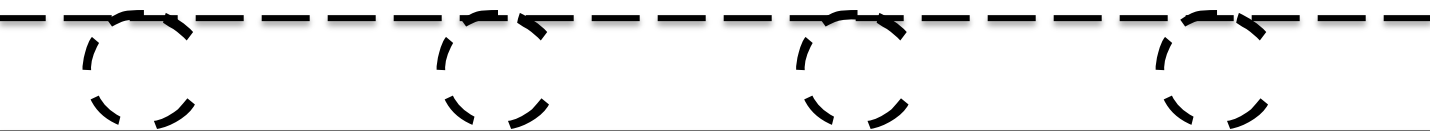
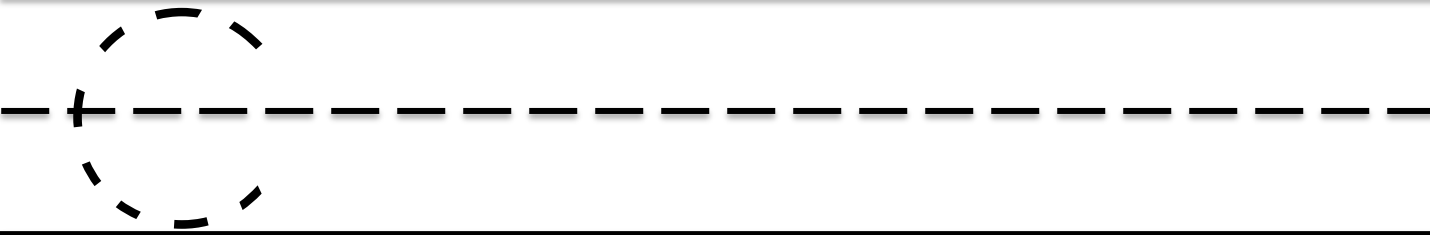
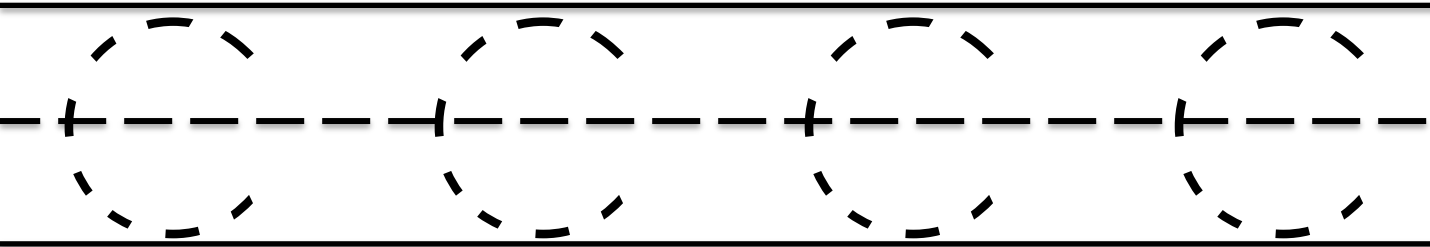

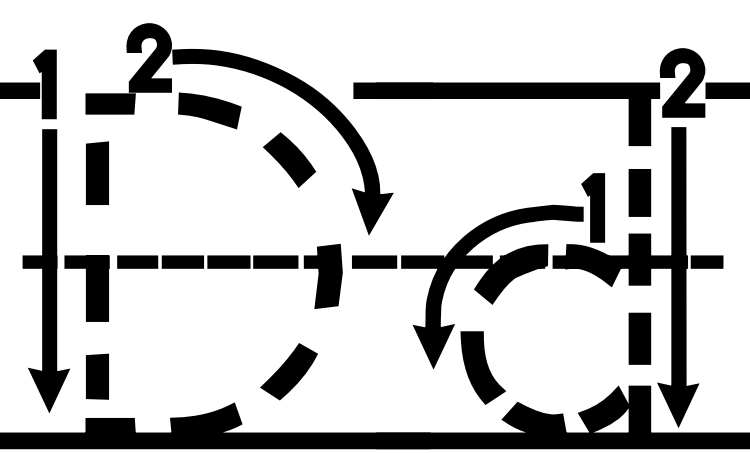

D is for
dog

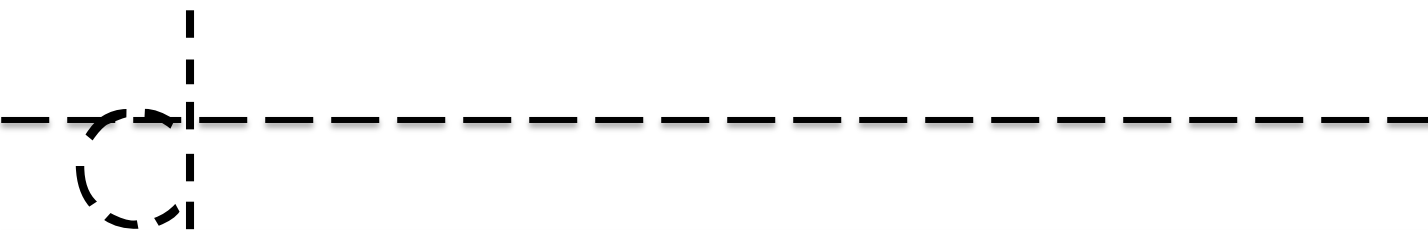
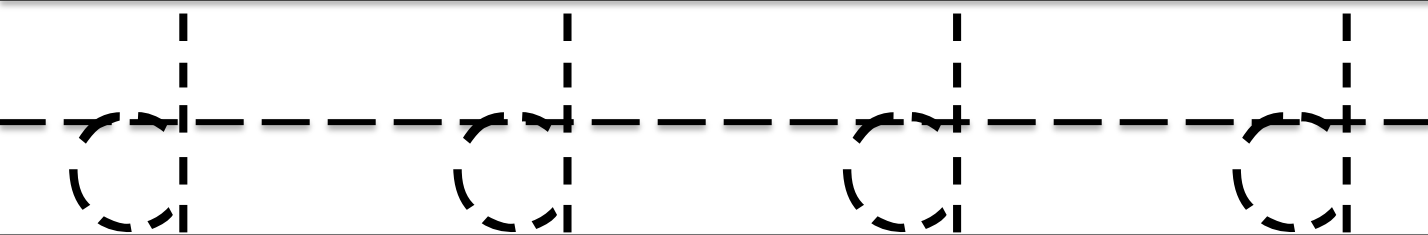
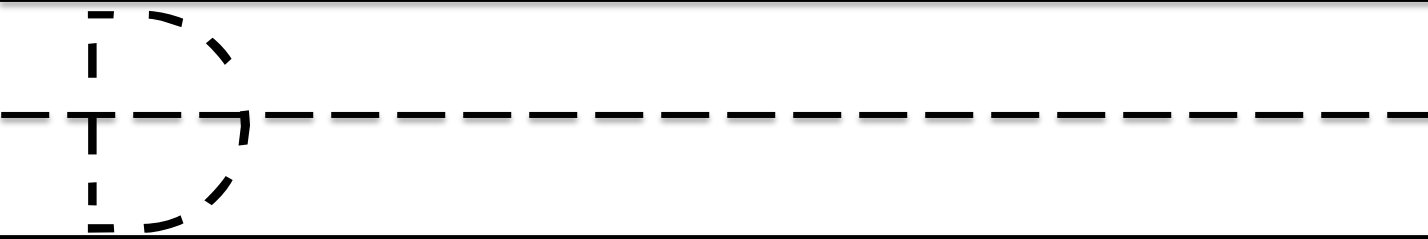
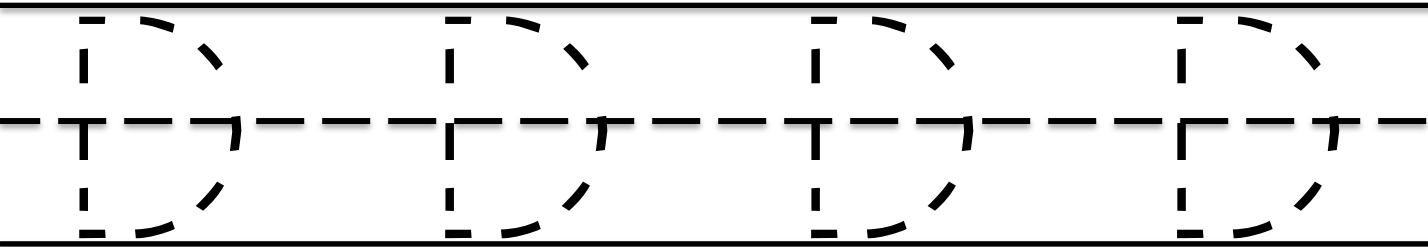

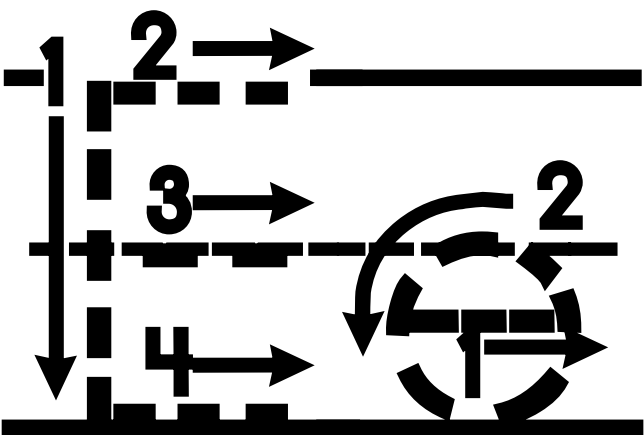

E is for
Eskimo

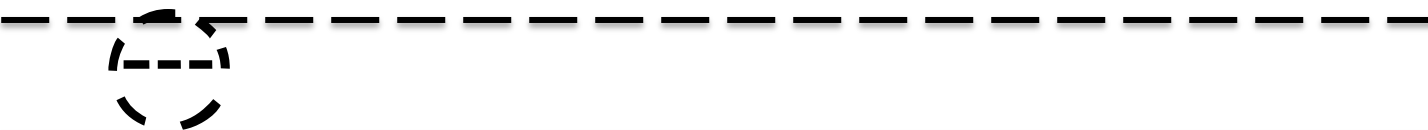
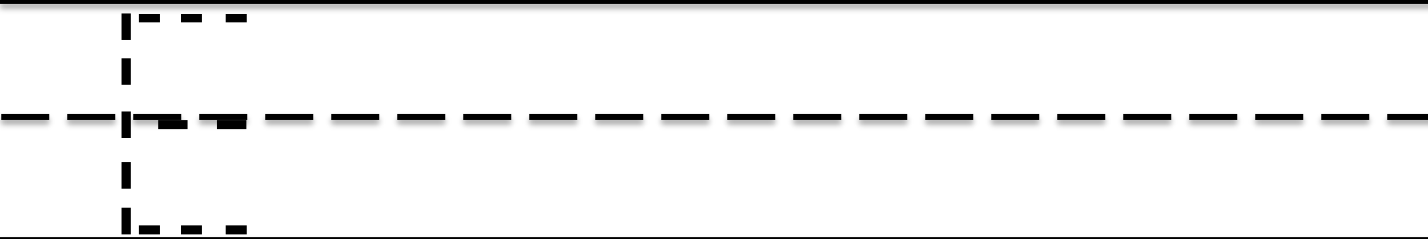
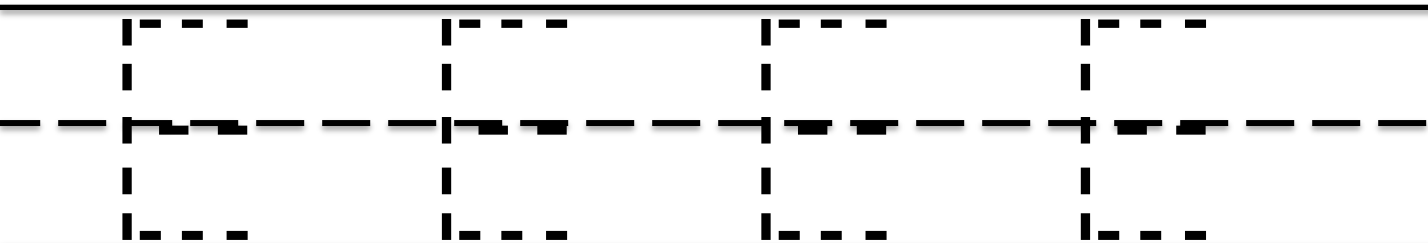

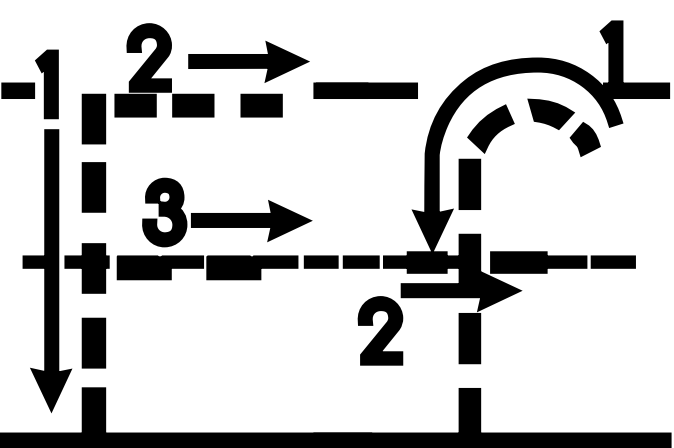

F is for frigid
weather

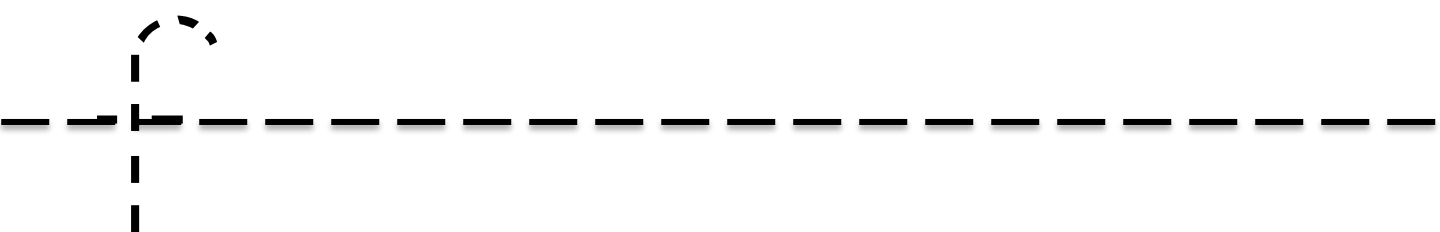
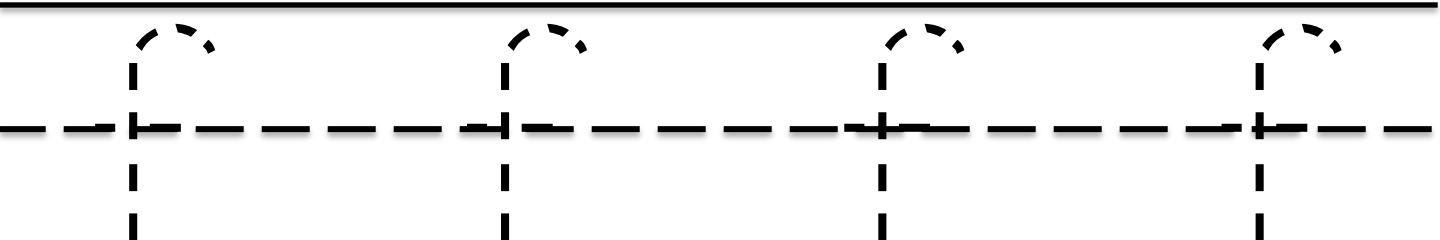
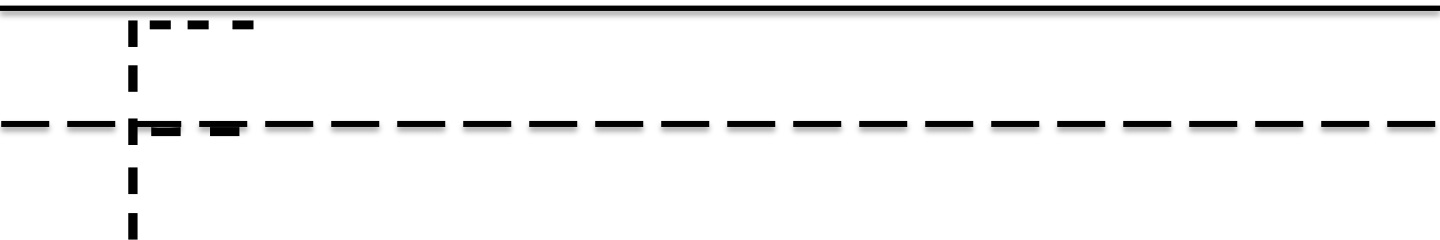
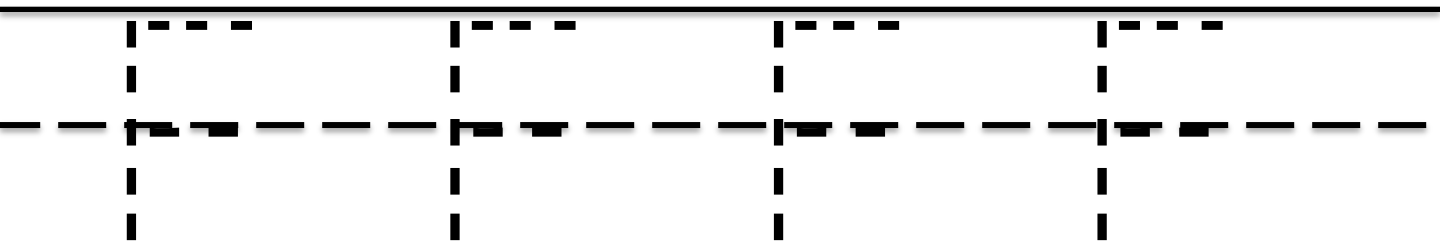
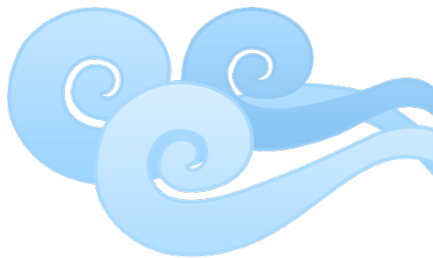

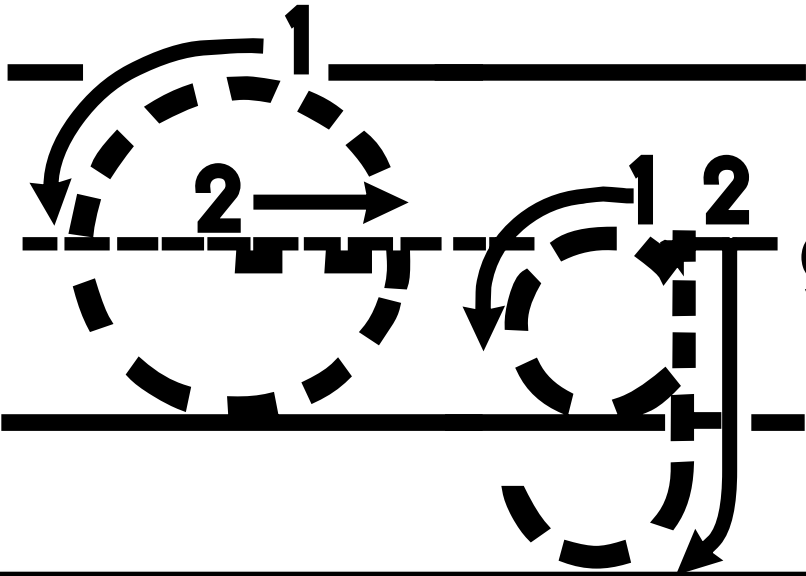

G is for
ground-
hog

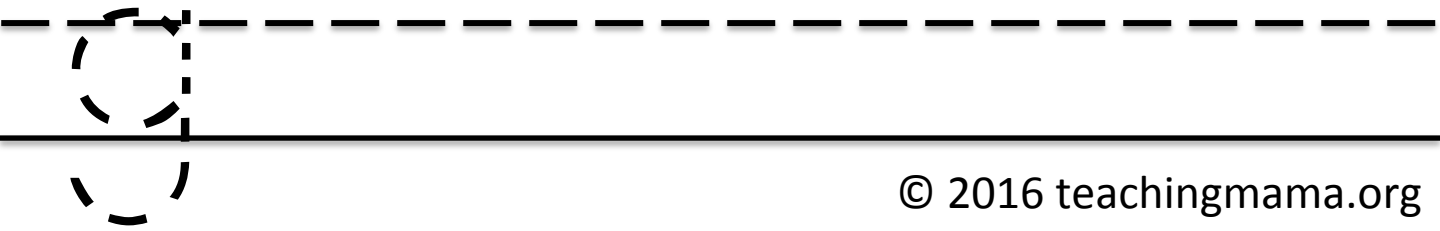
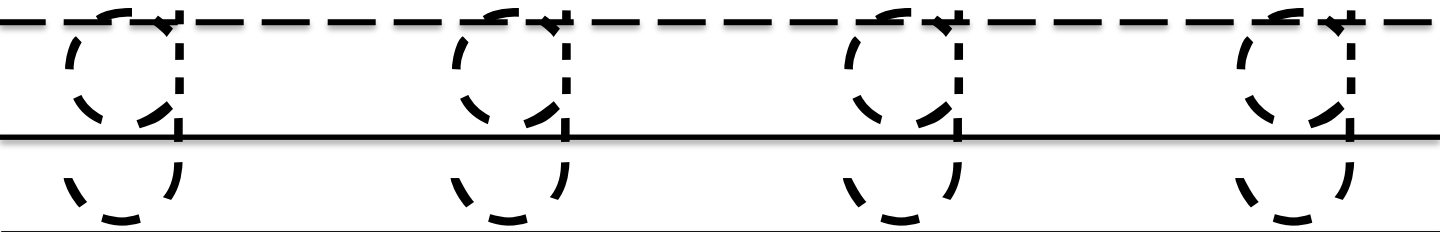
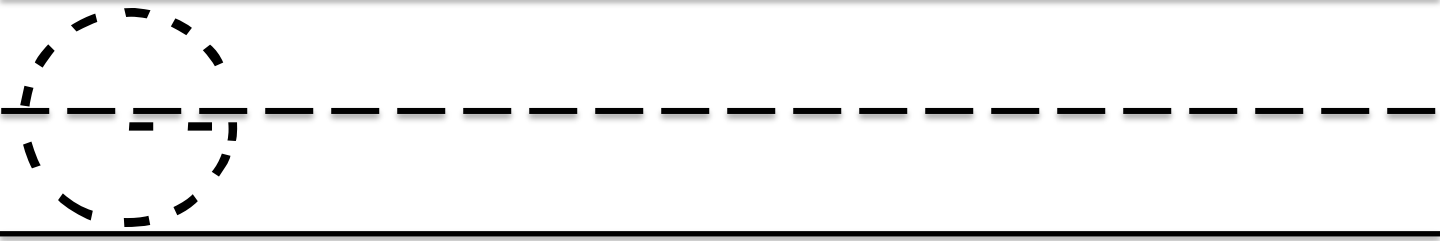
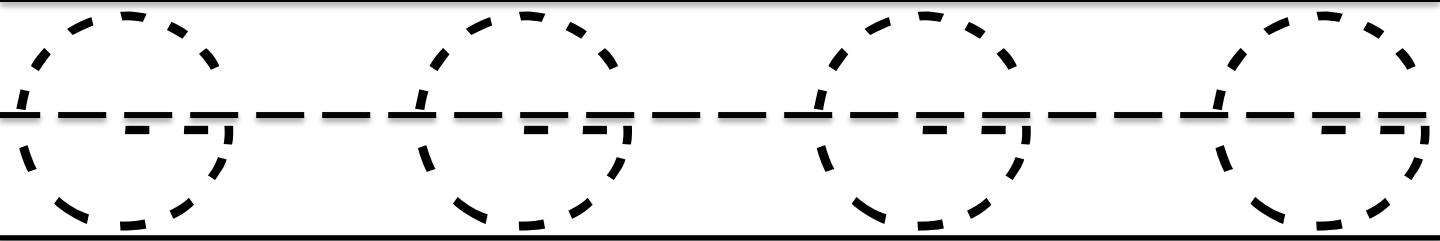
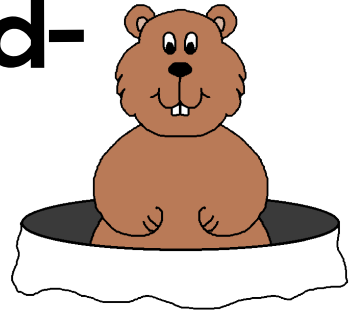

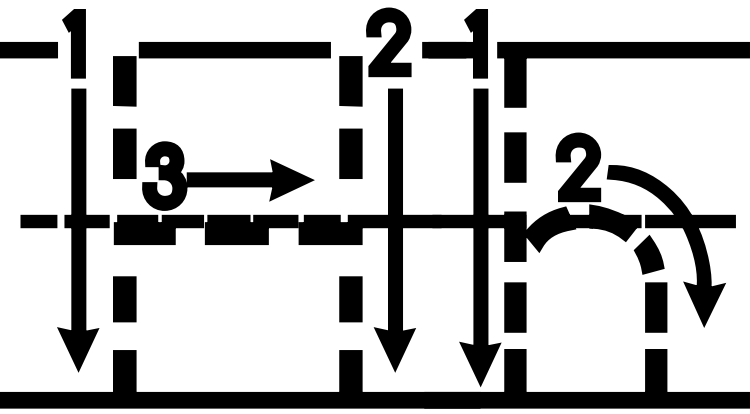

H is for hot
chocolate

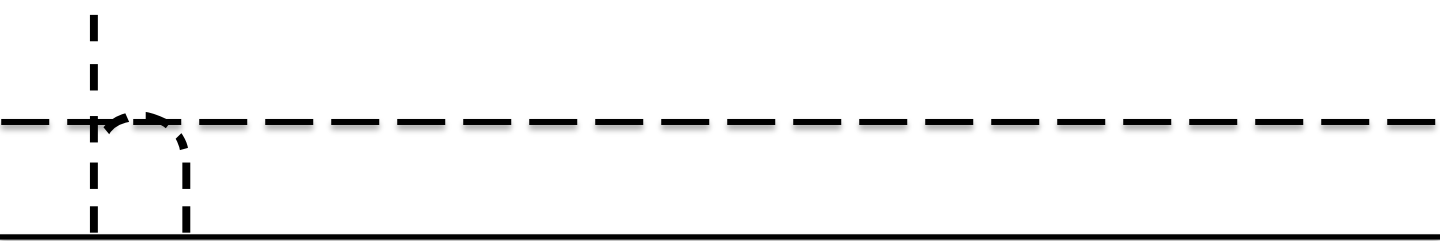
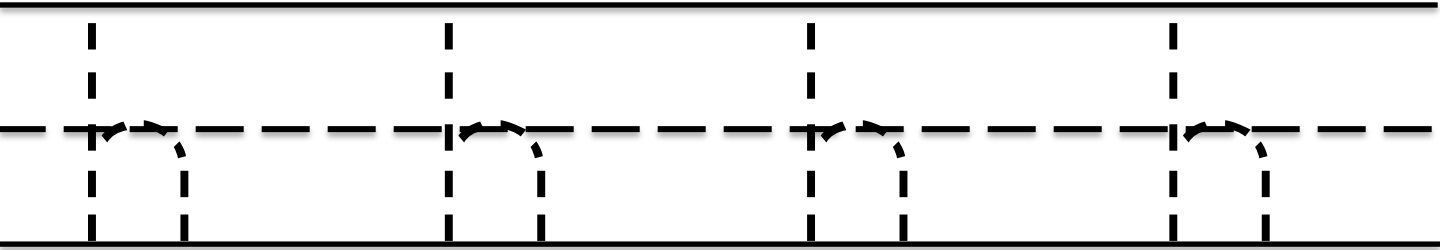
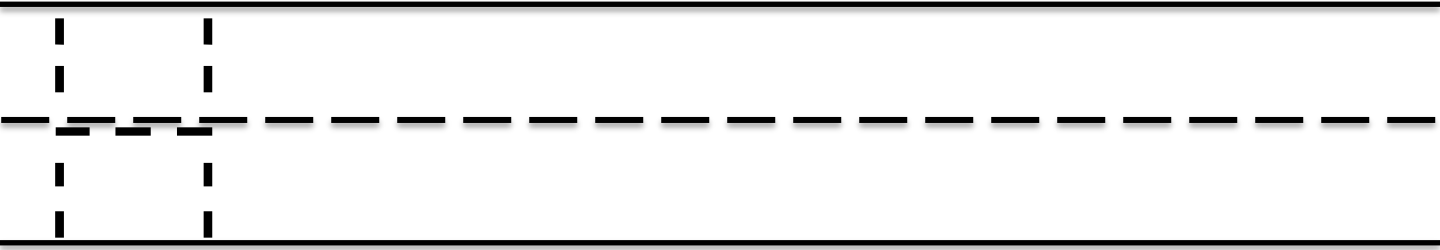
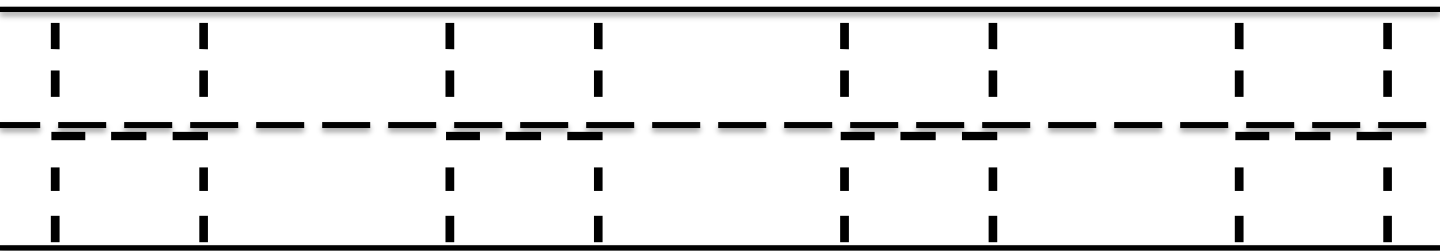

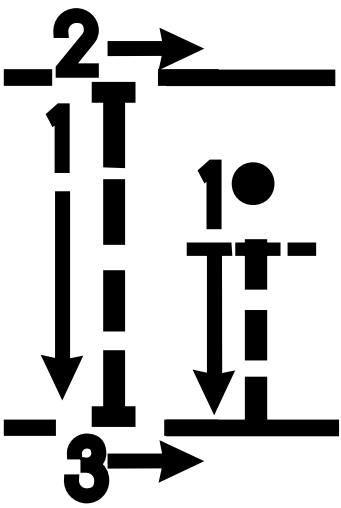

I is for
igloo

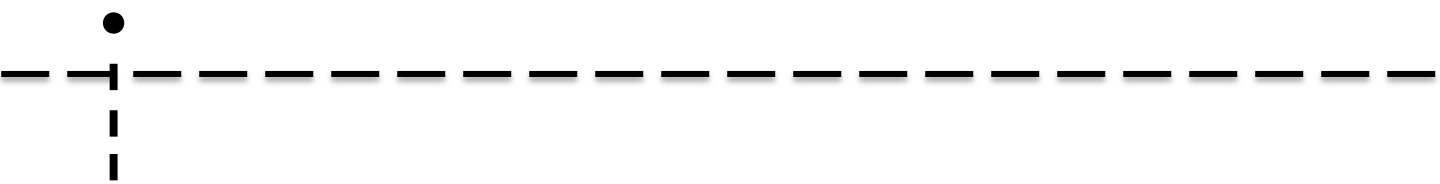
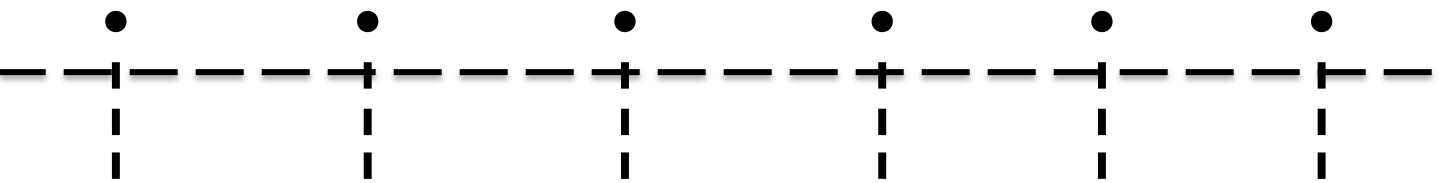
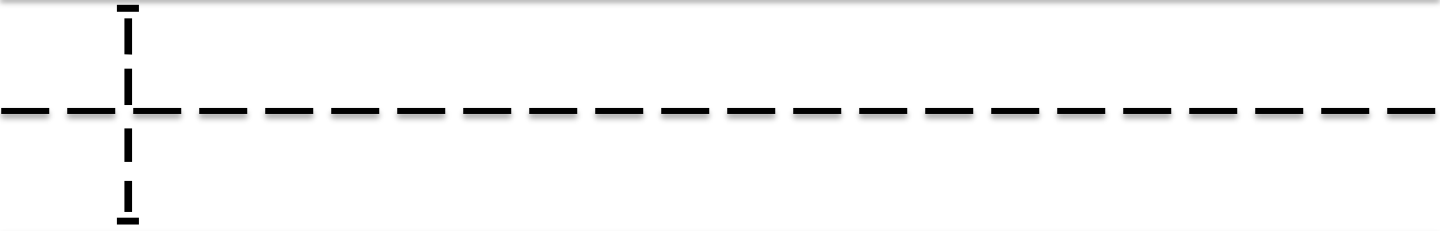
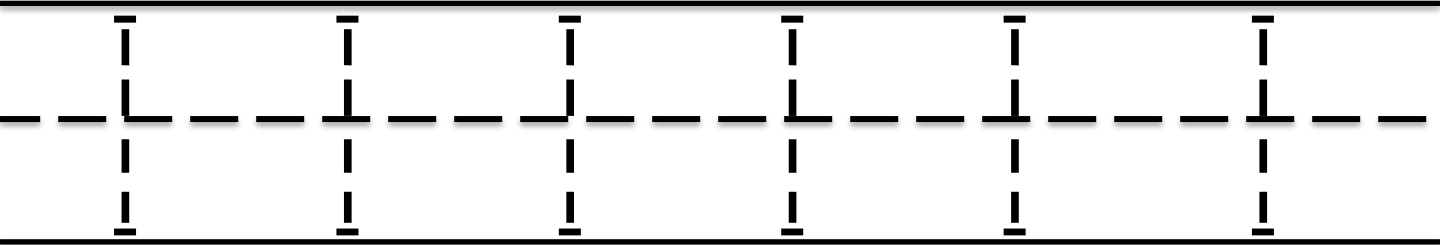
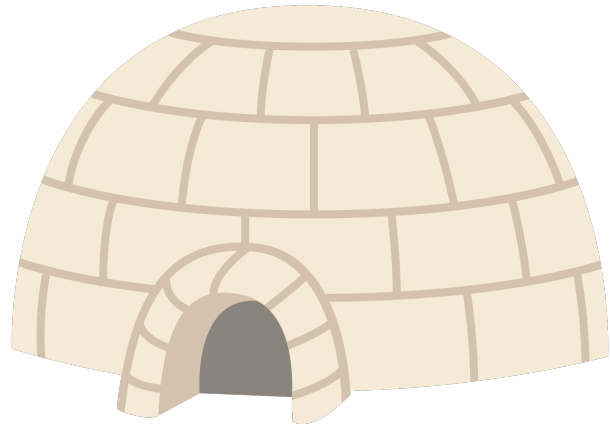

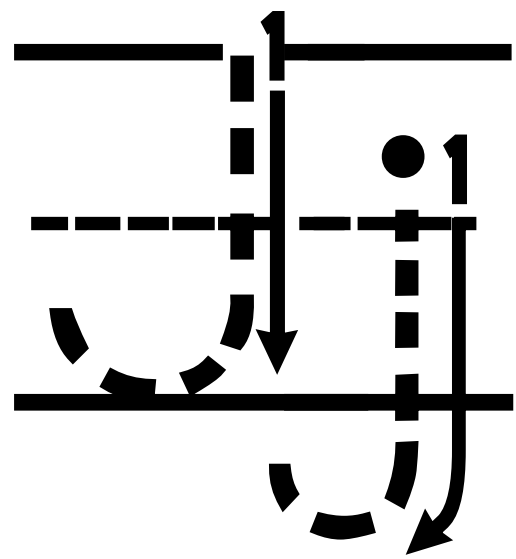

J is for
jacket

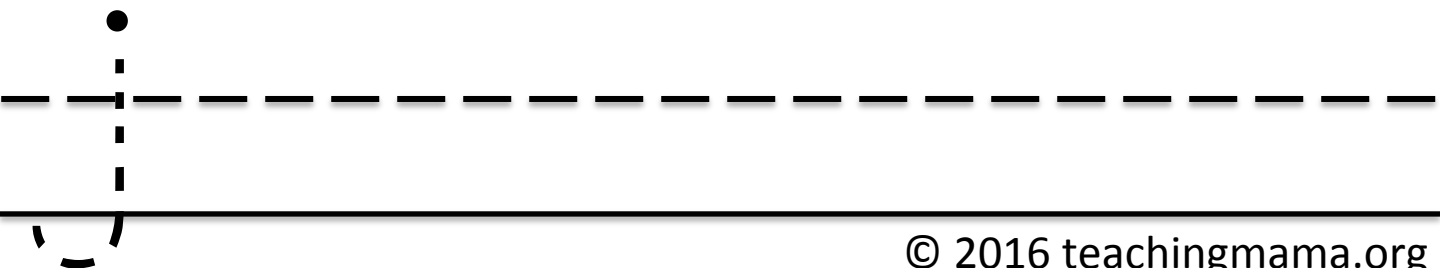
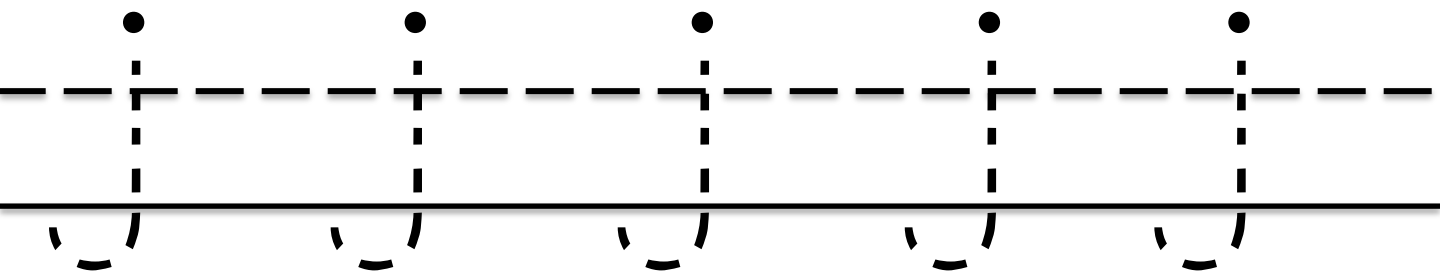
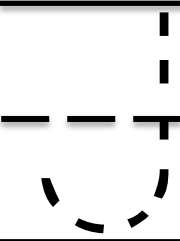
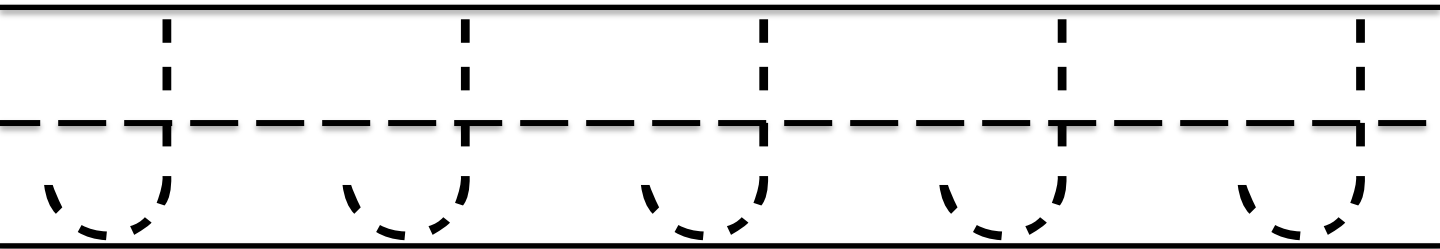

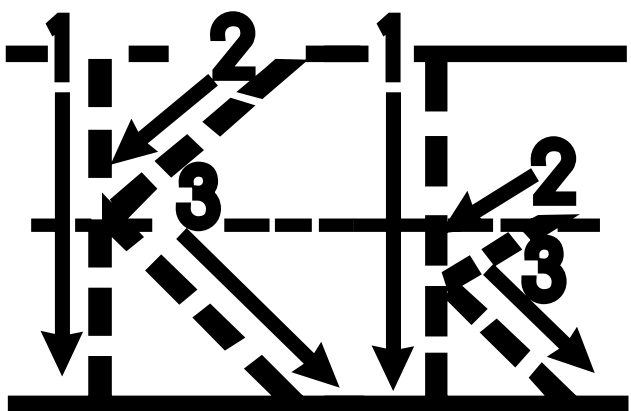

K is for
kettle

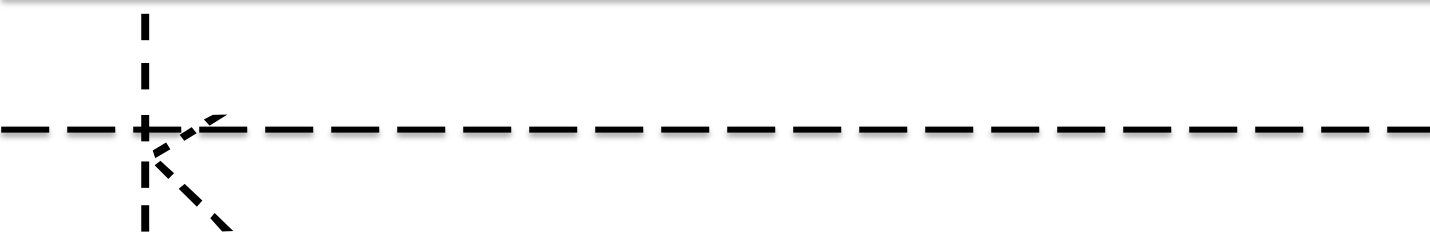
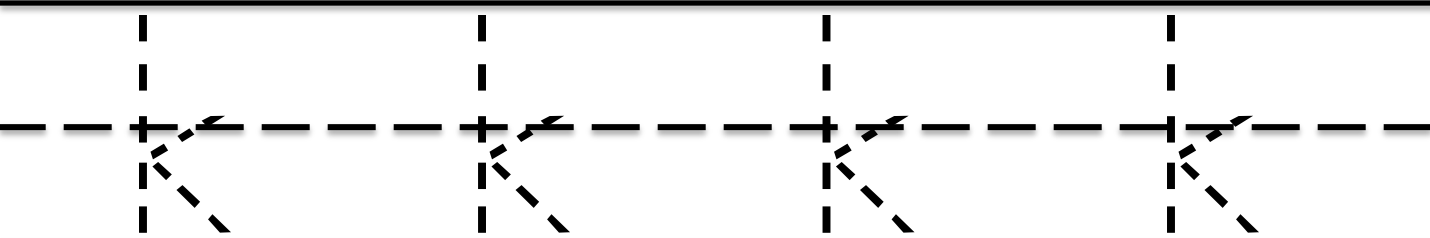
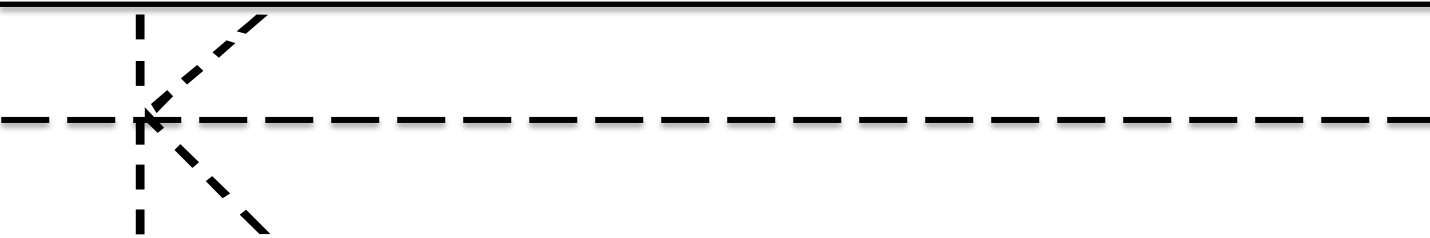
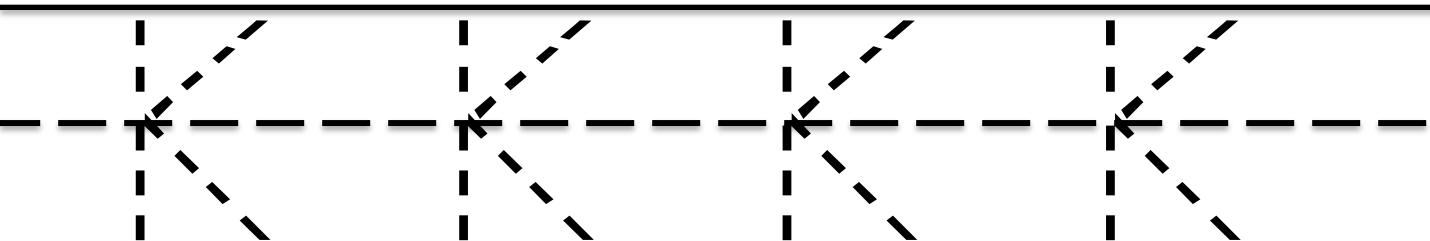

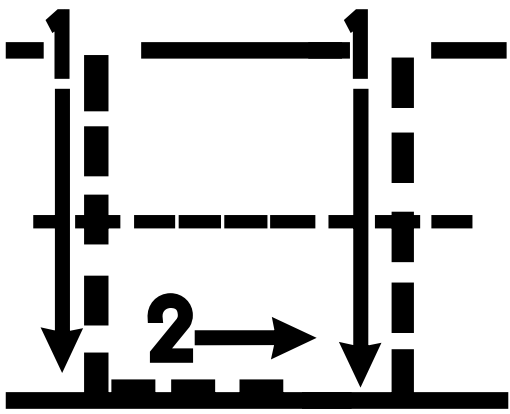

L is for logs

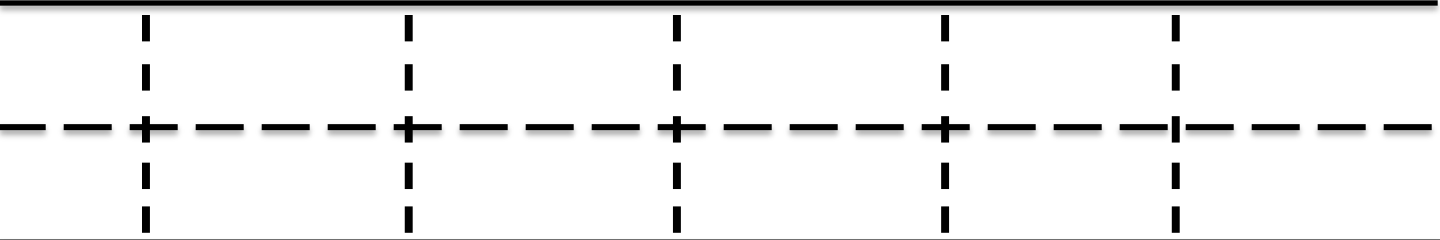
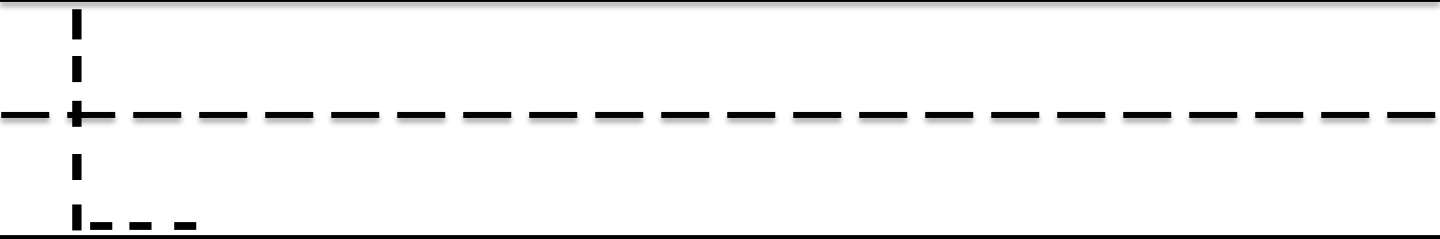
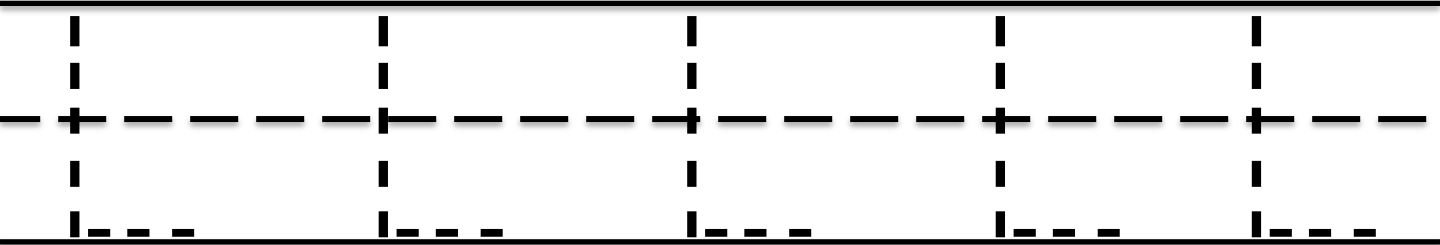

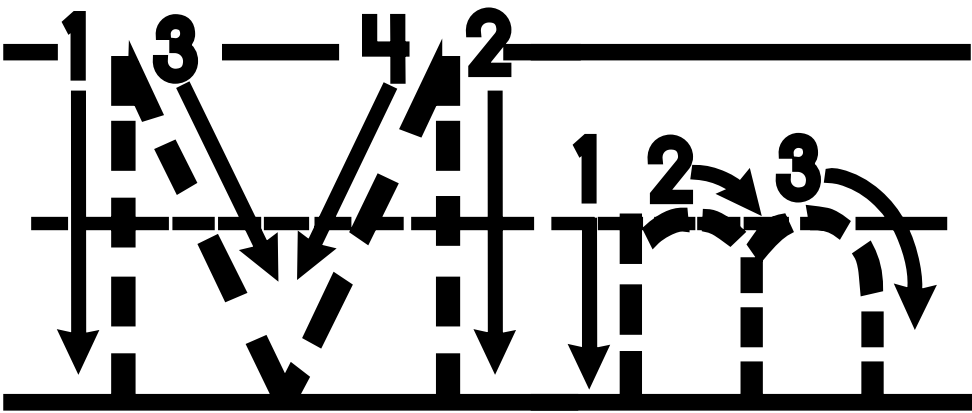

M is for
mittens

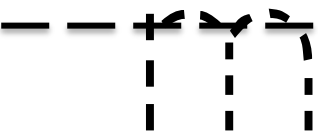
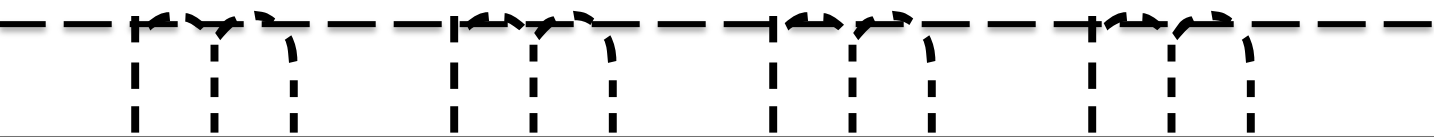
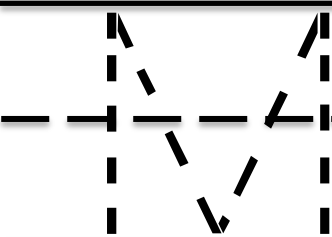
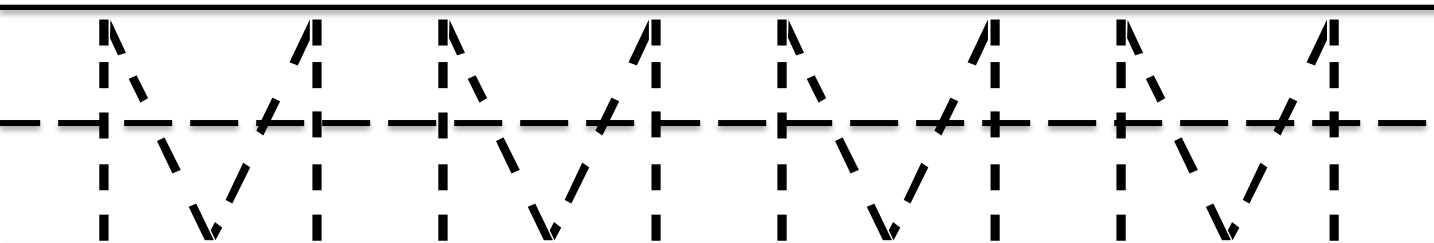

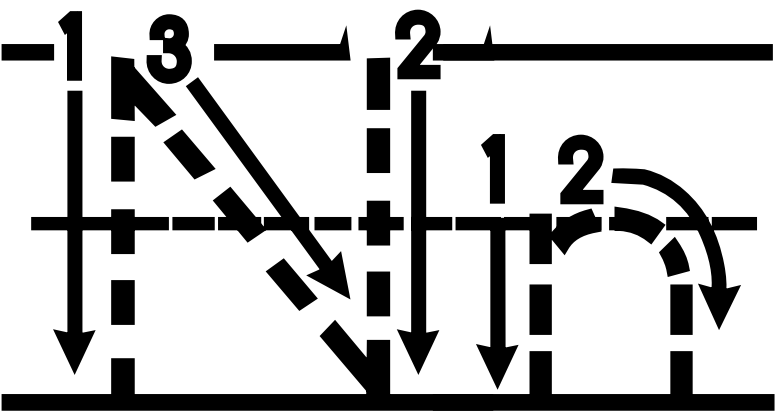

n is for
narwhal

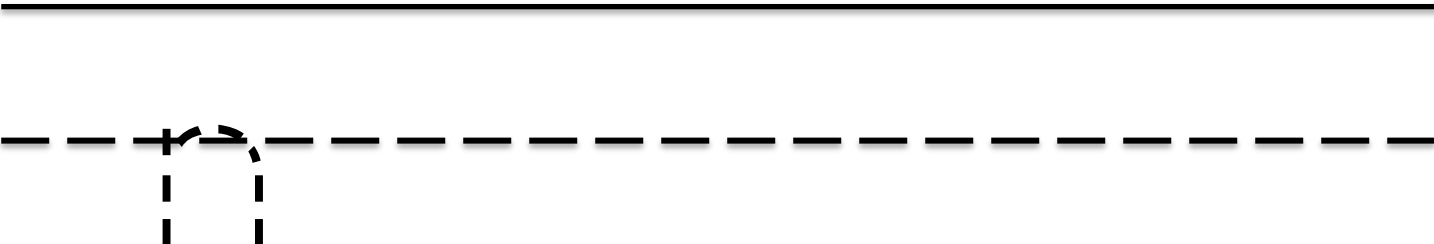
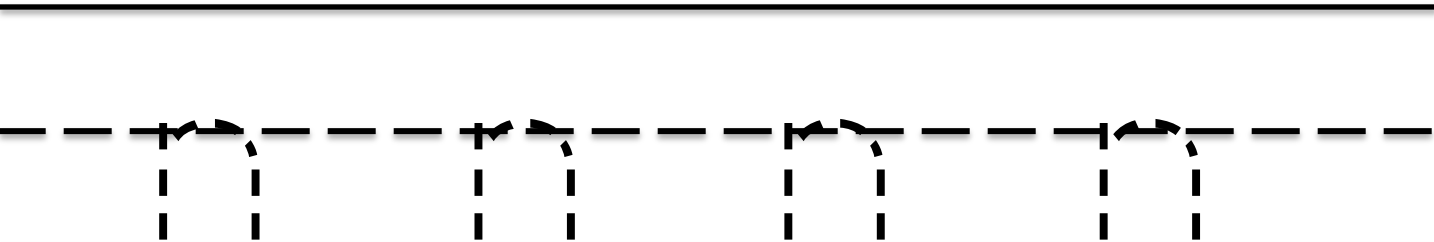
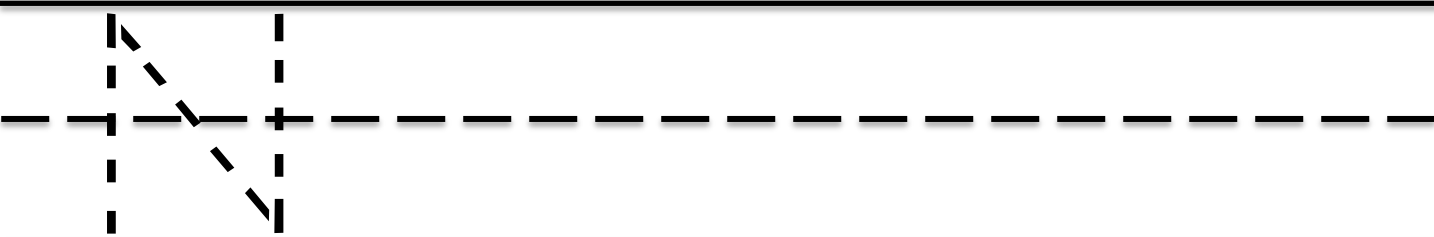
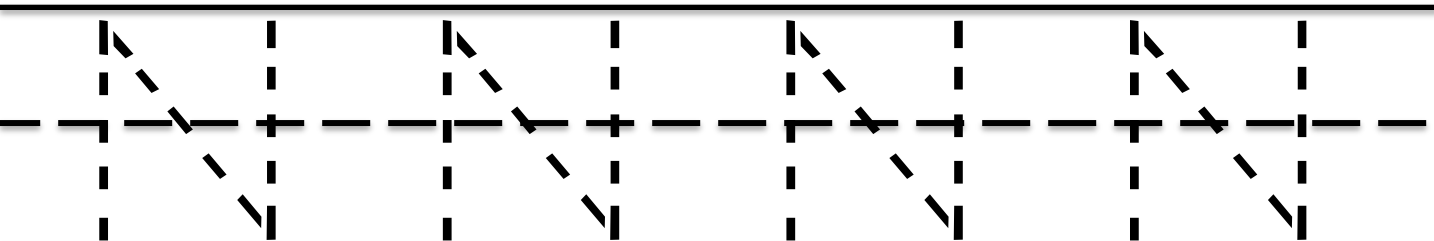
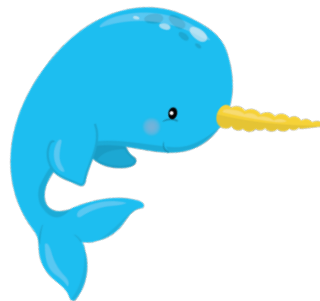

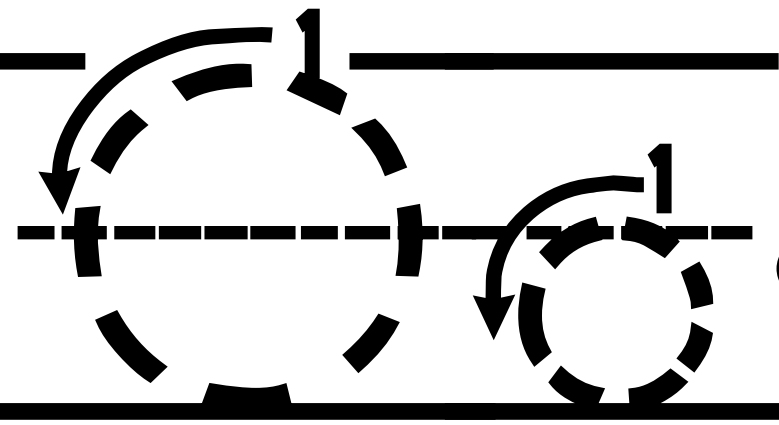

O is for
overcoat

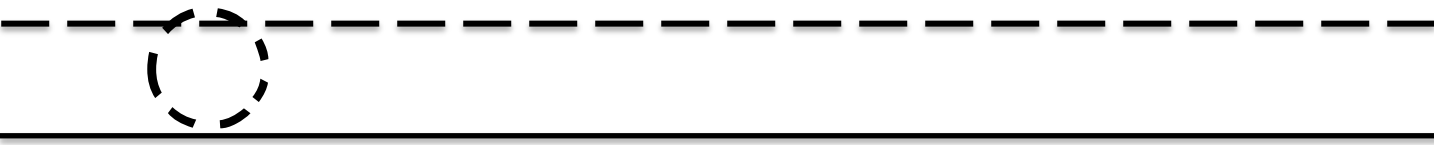
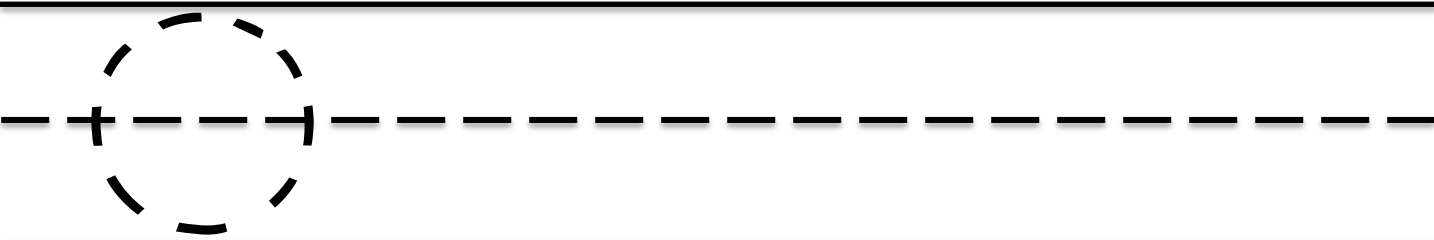
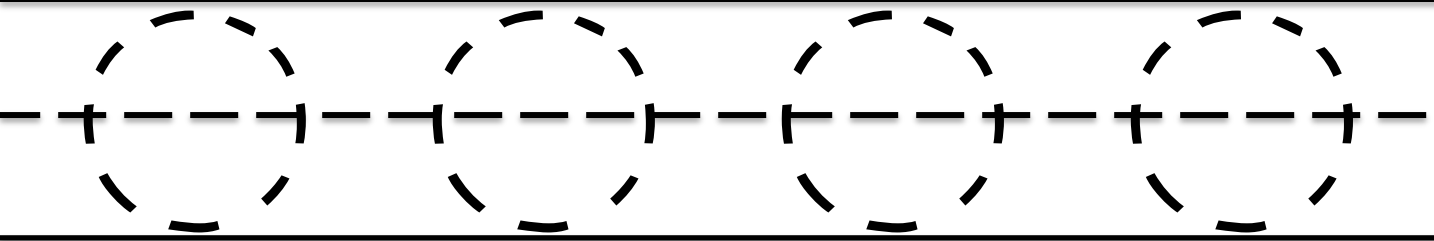

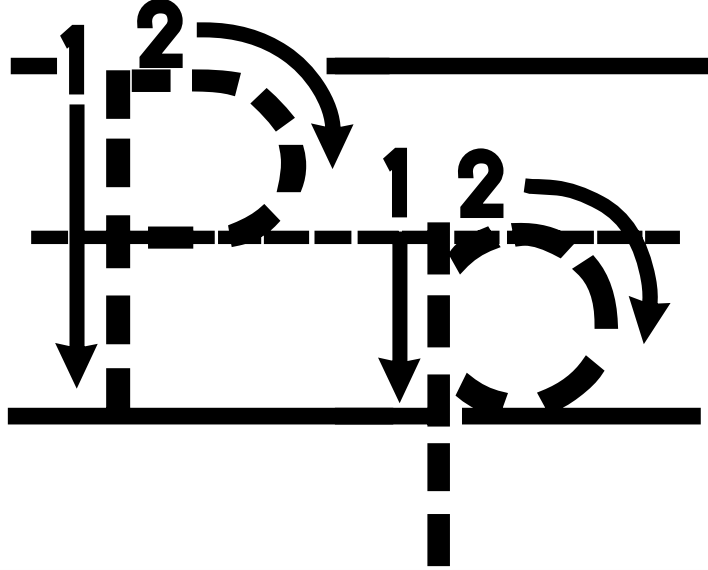

P is for
penguin

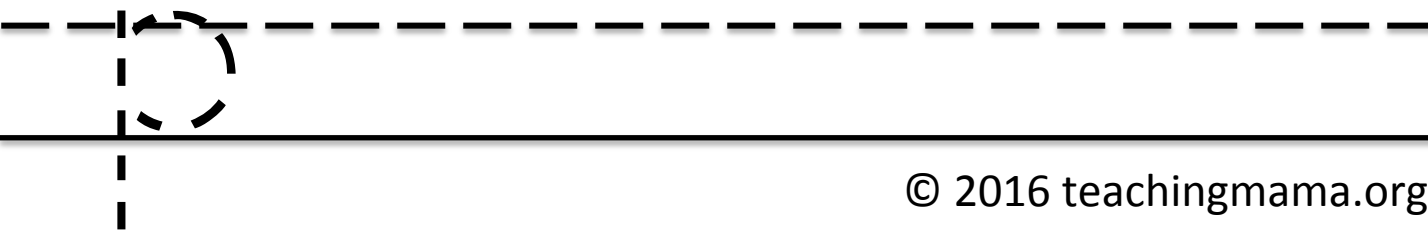
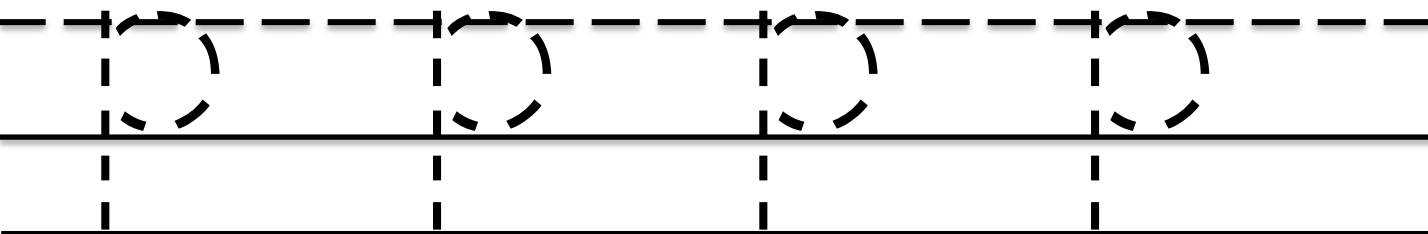
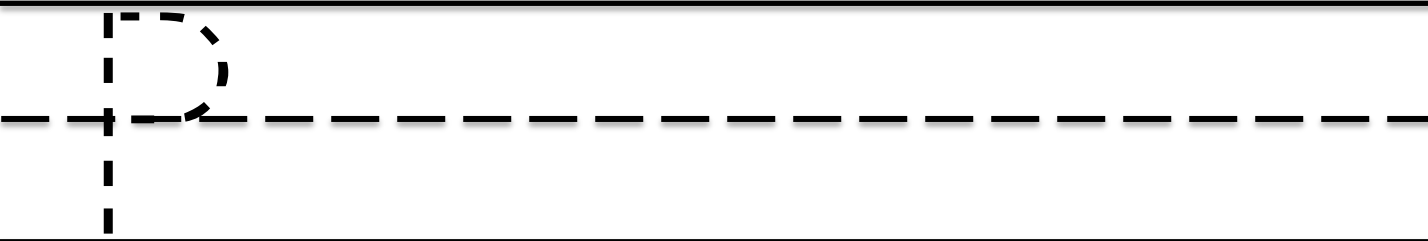
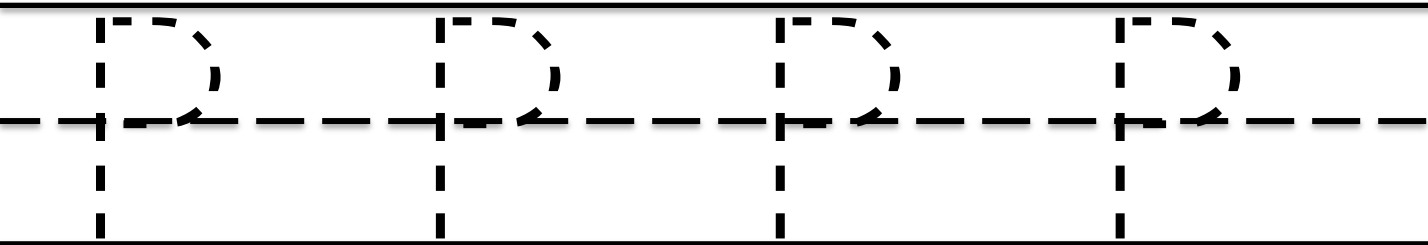
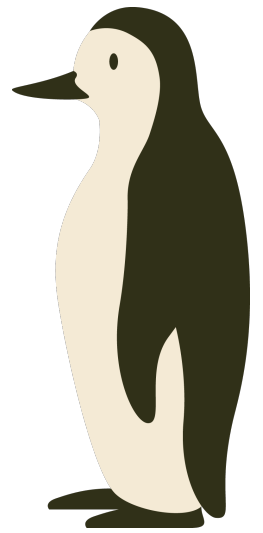

Q is for quilt

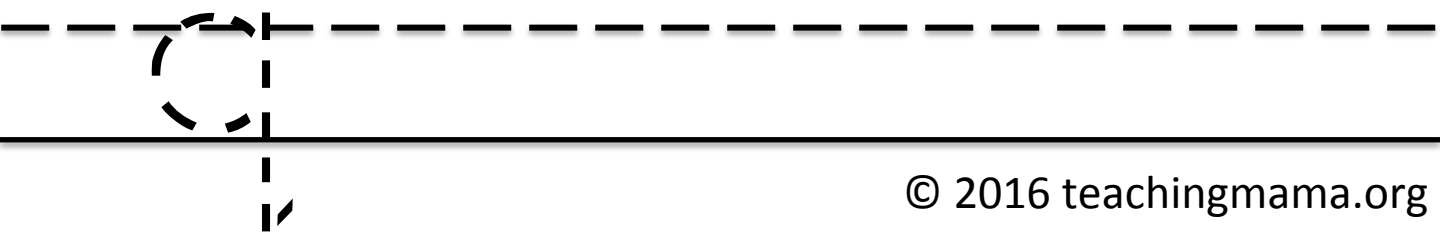
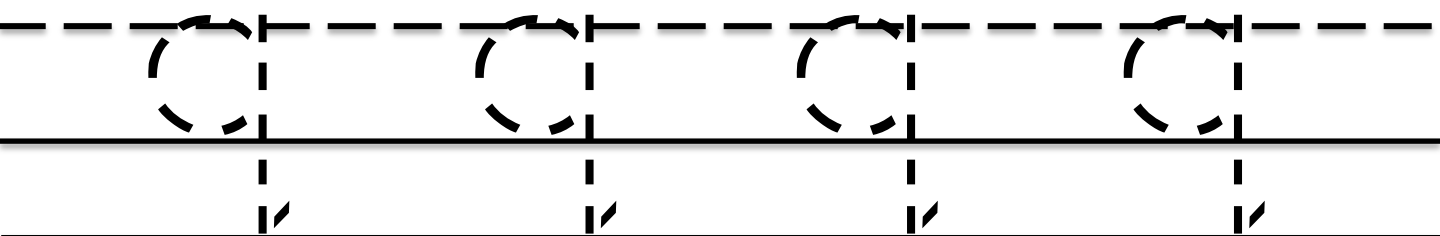
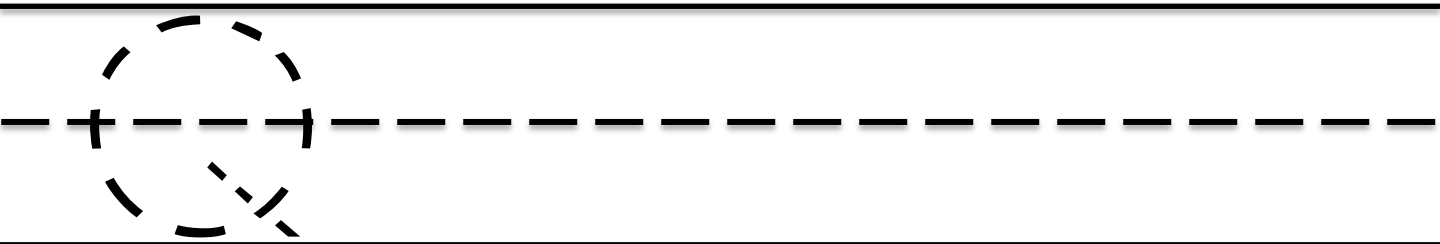
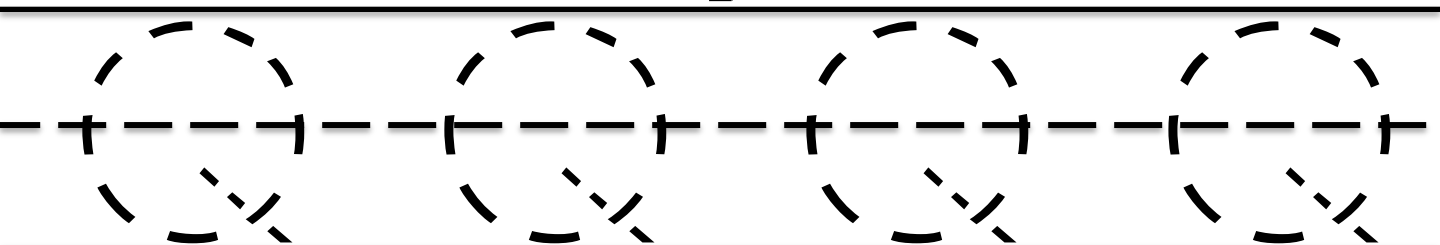
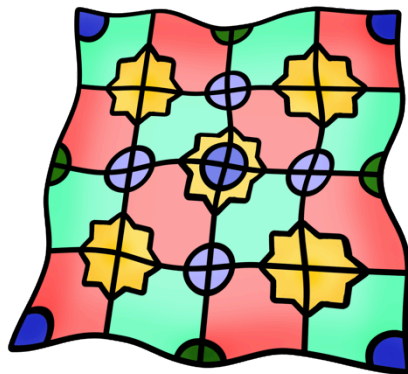
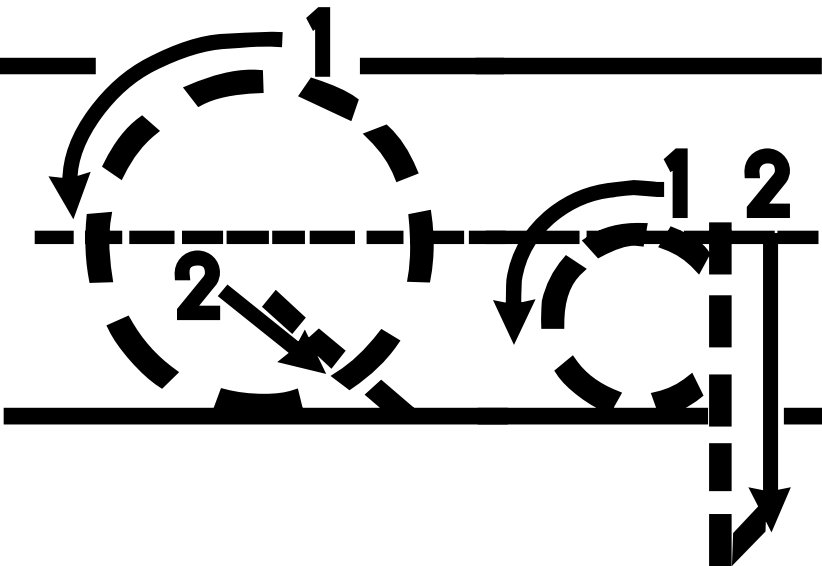

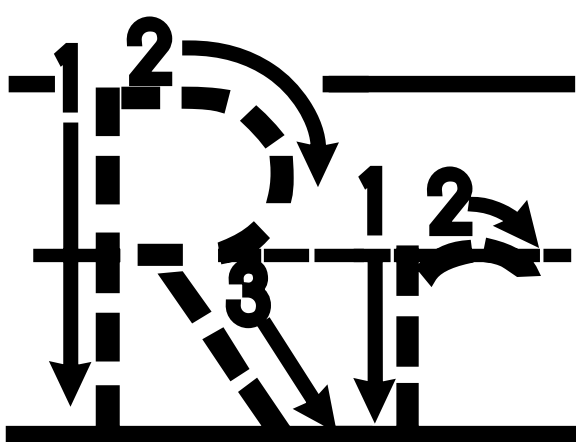

R is for
reindeer

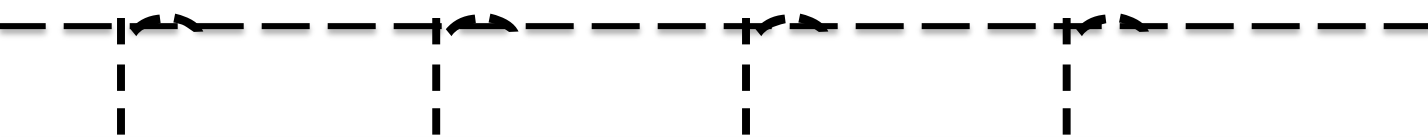
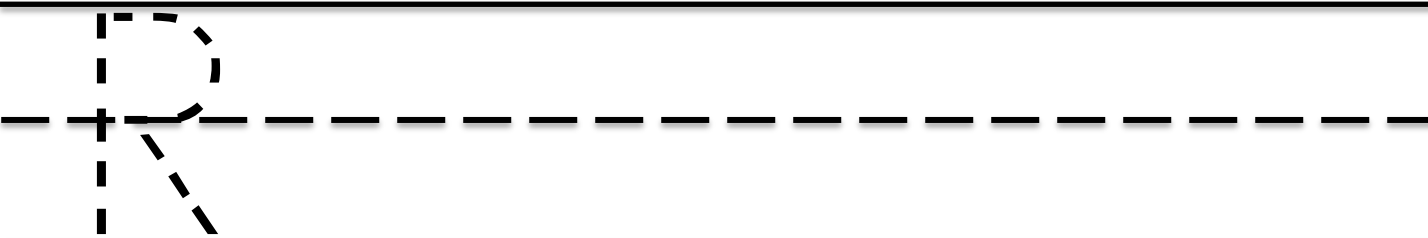
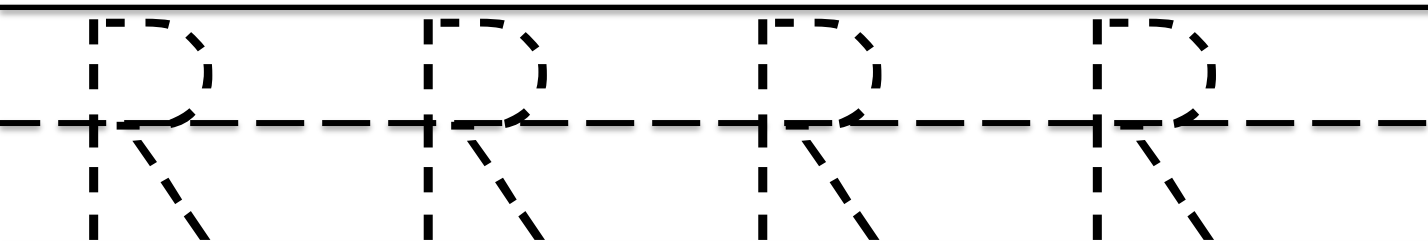

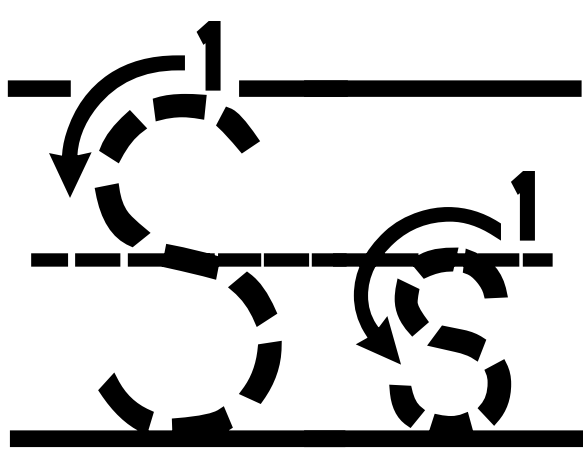

S is for
snowman

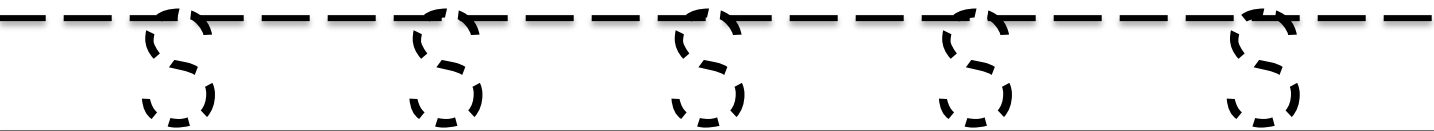
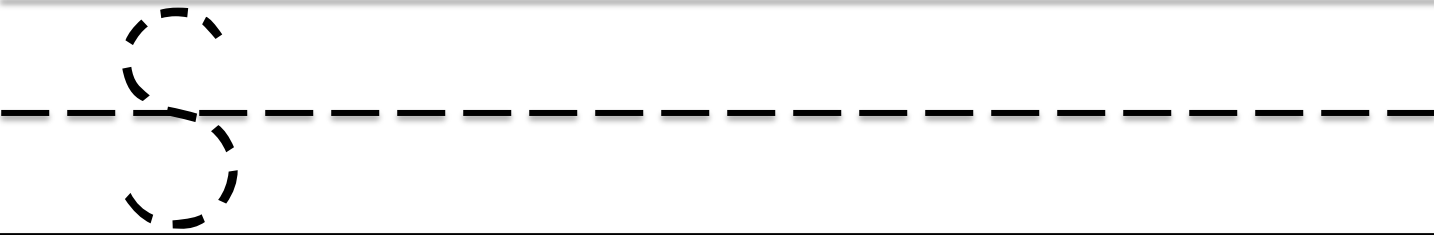
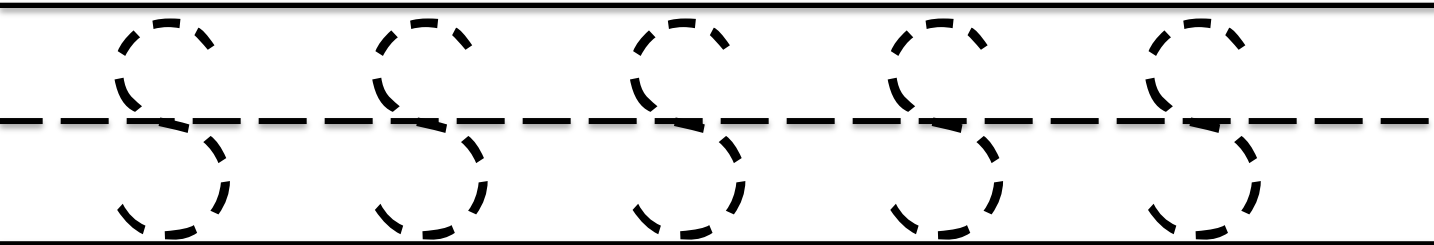

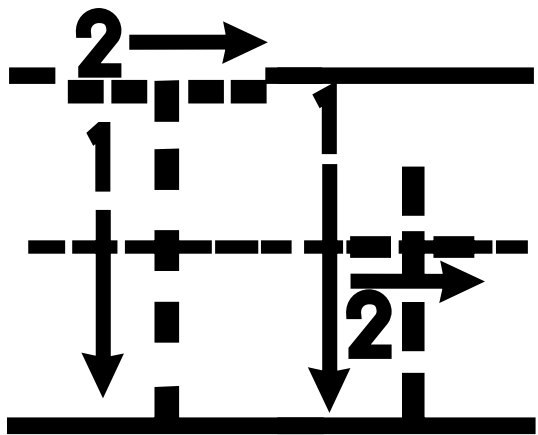

T is for
thermometer

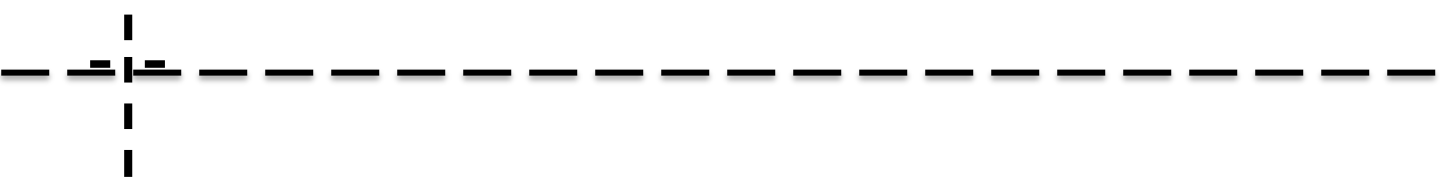
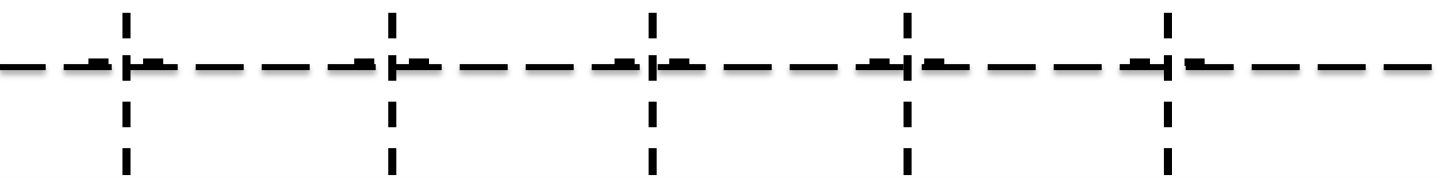
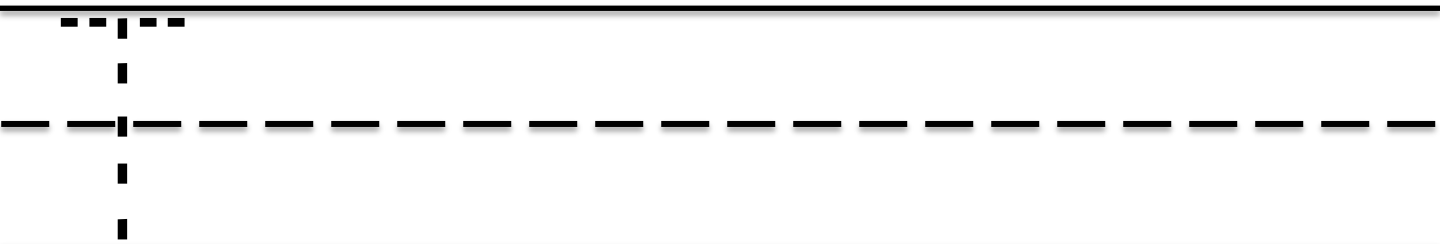
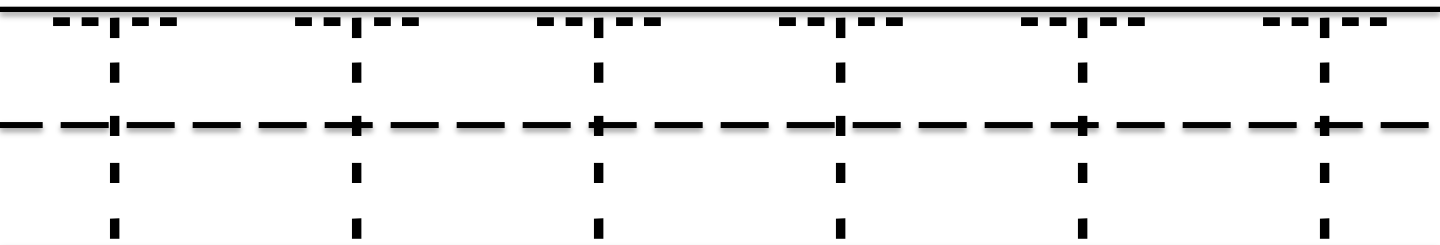
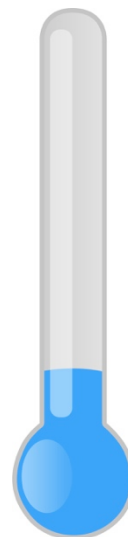

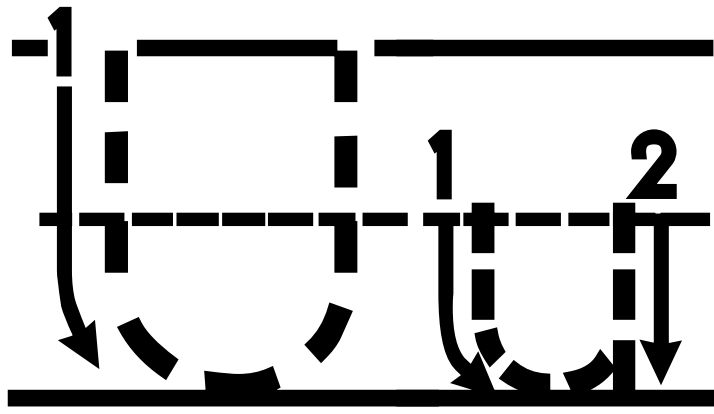

U is for long
underwear

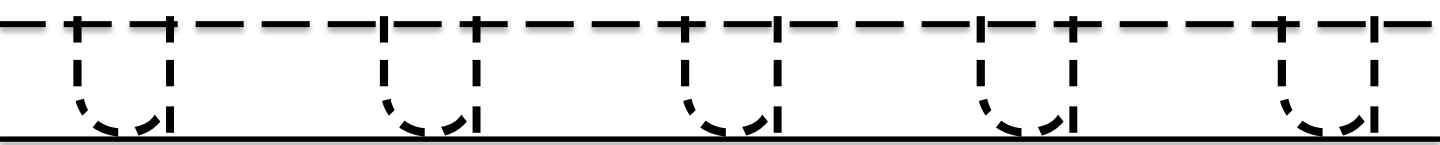
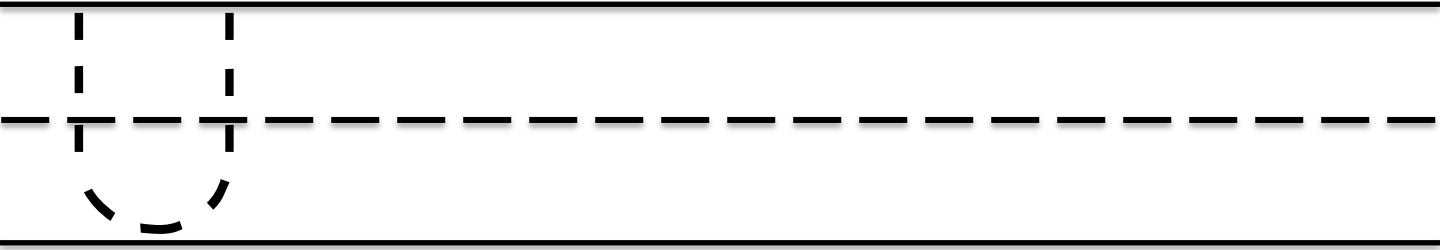
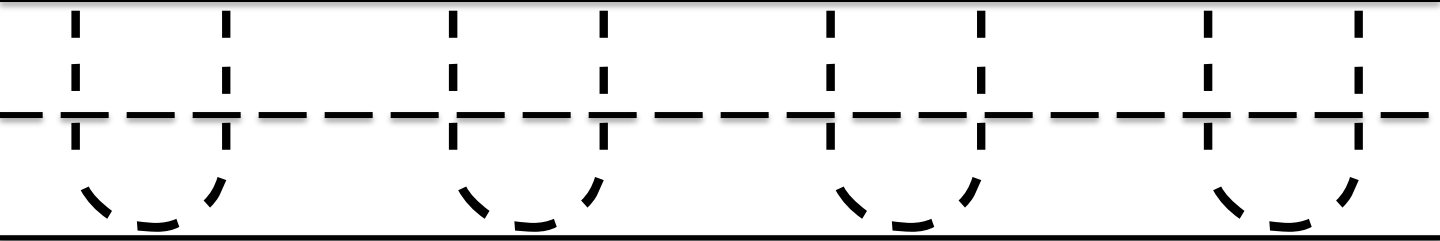

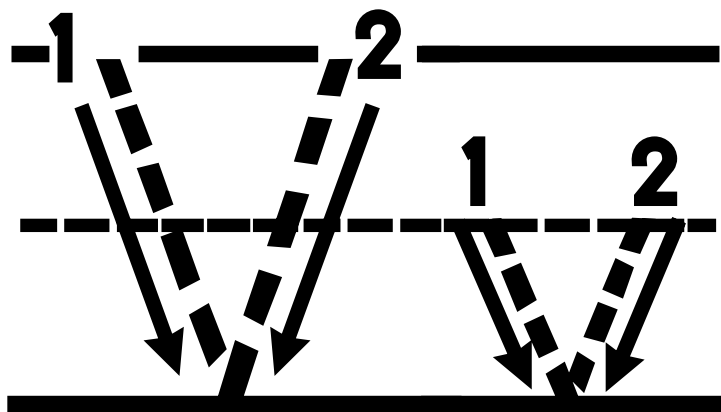

V is for vest

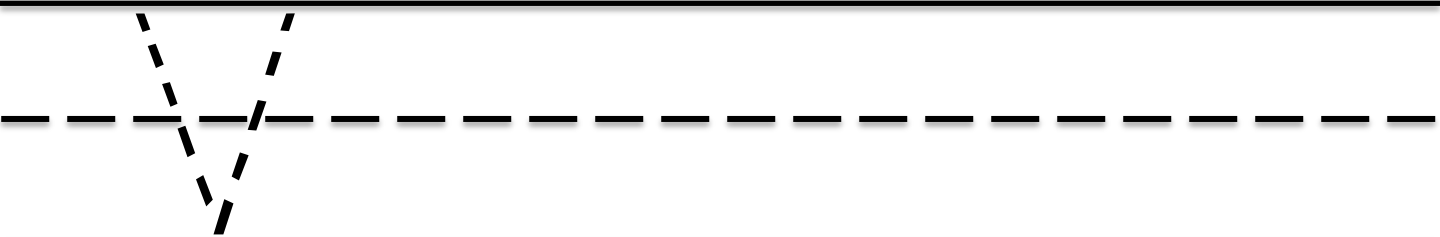
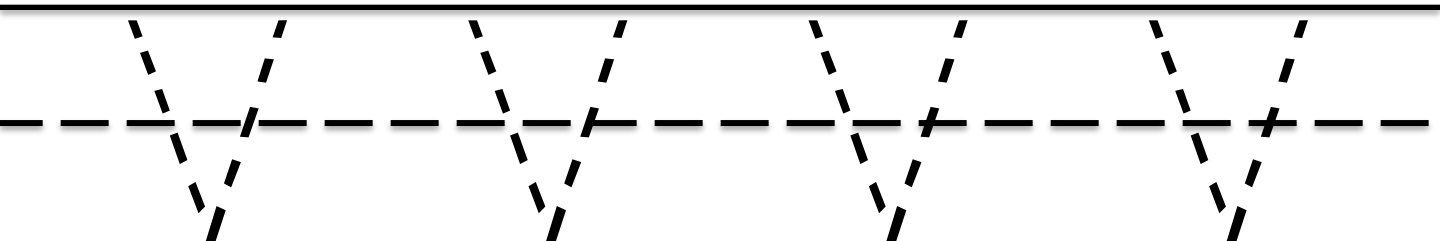

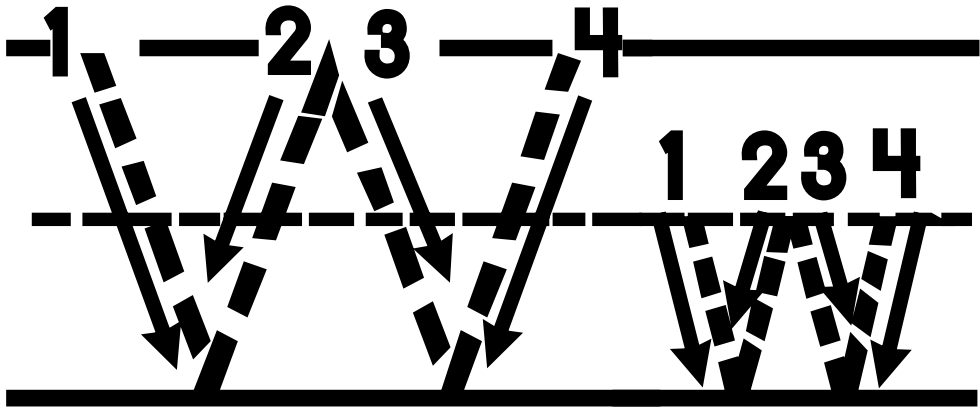

W is for
walrus.

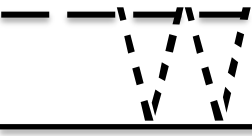
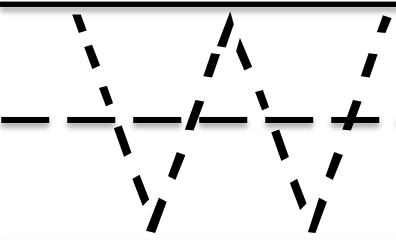
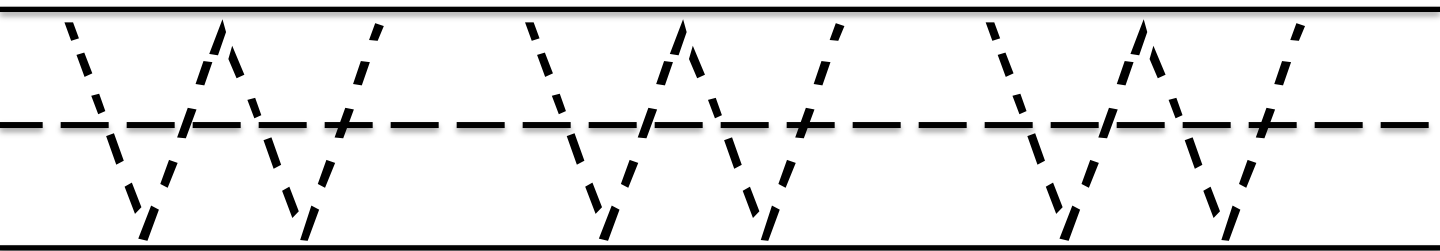

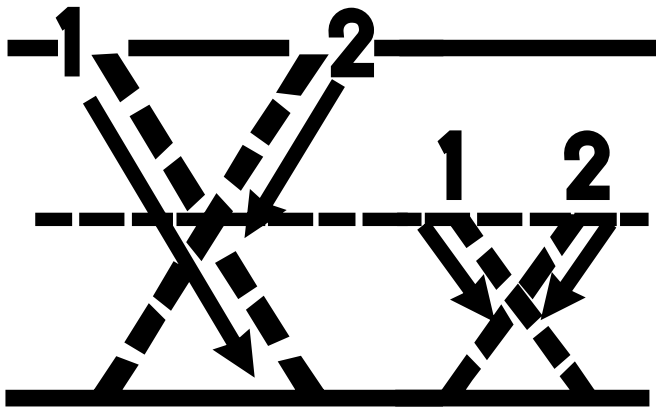

X is for
extra
clothes

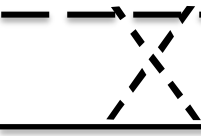
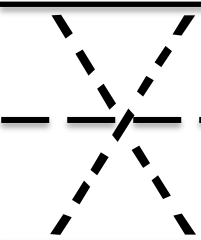
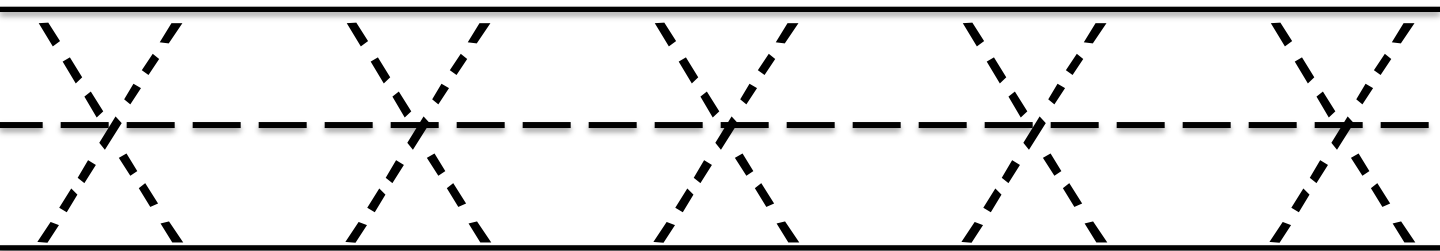

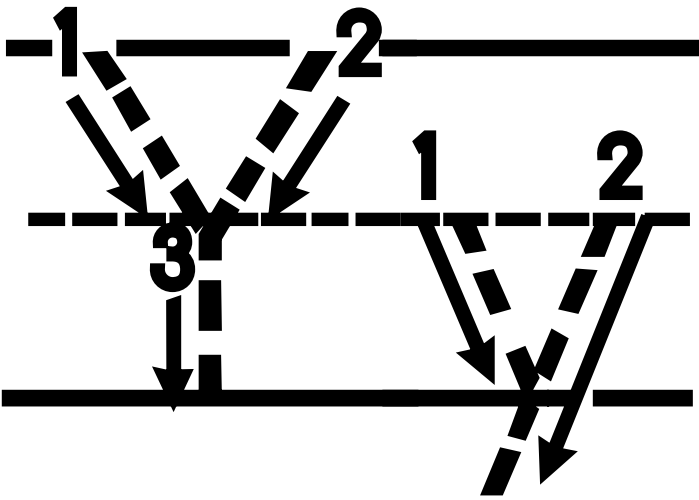

Y is for
yummy treats

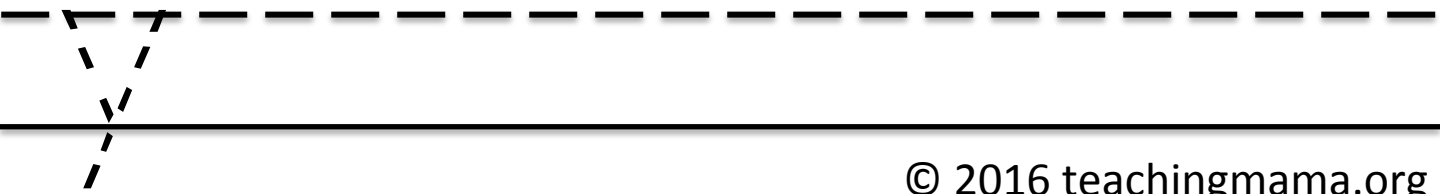
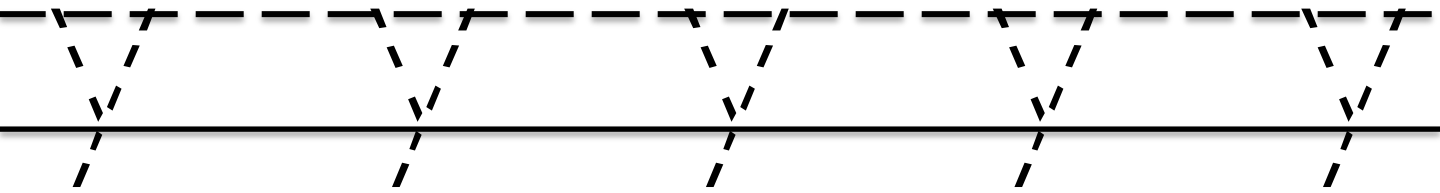
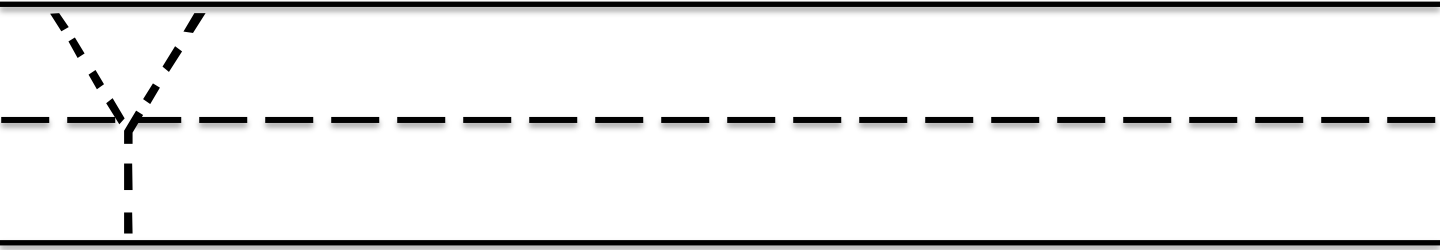
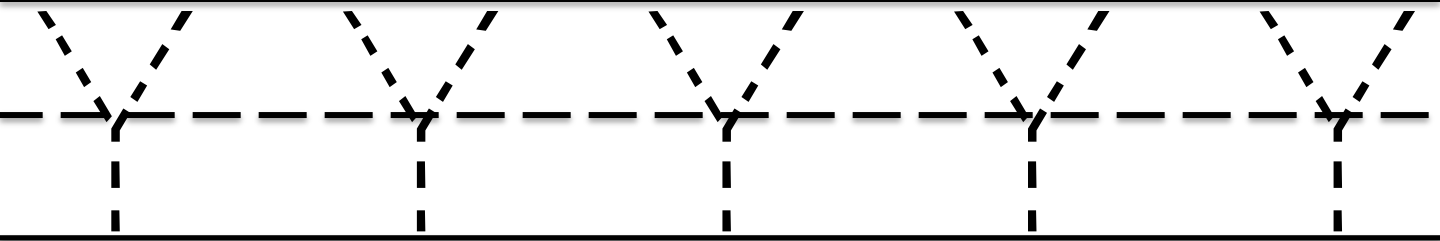

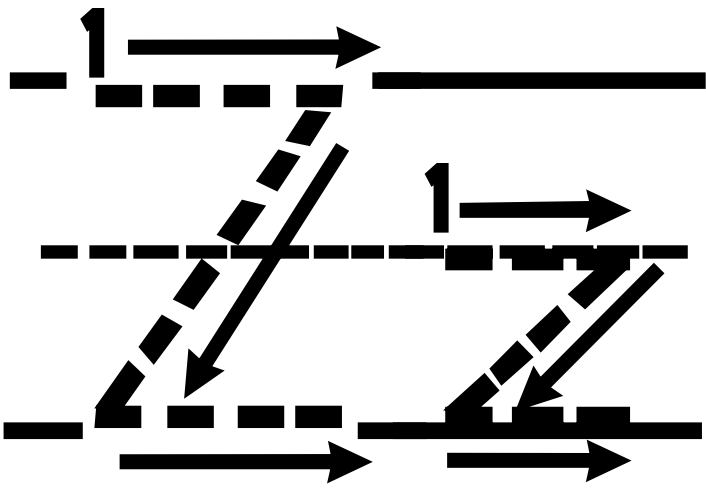

Z is for
zipper

